

# Medialon Showmaster Hardware Manual

User Reference

## Trademark Information

Medialon is a trademark of 7thSense Design Ltd. Product or company names that mentioned in 7thSense Design Ltd publications are tradenames or trademarks of their respective owners, and such trademarks may also be registered in their respective countries.

## Copyright Information

All Rights Reserved. This document is copyrighted © by 7thSense Design Ltd and shall not be reproduced or copied without express written authorization from 7thSense Design Ltd.

The information in this document is subject to change without notice. 7thSense Design Ltd assumes no responsibility for errors, and/or omissions contained in this information.

## Document Revision

Date	Document edition	Software version	Revision details	Author/Editor
May 2020	M569-1	Medialon Manager 6.7 Medialon Showmaster Editor 2.7.0		Eric Cantrell Andie Davidson (ed)
August 2022	M569-2	Medialon Manager 7 Medialon Showmaster Editor 2.7.0	Reformatted	Andie Davidson (ed)

## M569-2

---

# Contents

---

<b>1 About this Manual</b> .....	<b>3</b>
1.1 Prerequisites.....	3
1.2 Objective of this Manual.....	3
<b>2 Showmaster Overview</b> .....	<b>4</b>
2.1 Embedded Show Controllers.....	4
2.1.1 Showmaster Architecture .....	8
2.1.2 Medialon Showmaster Modes .....	8
2.1.3 Recovery Tool.....	9
2.2 Showmaster Mini Description .....	10
2.2.1 Contents of the Package.....	10
2.2.2 Getting Started .....	10
2.2.3 Front Panel Controls .....	10
2.2.4 Side Panel.....	10
2.2.5 Mounting .....	11
2.2.6 Technical Specifications .....	11
2.3 Showmaster LE Description .....	13
2.3.1 Contents of the Package.....	13
2.3.2 Getting Started .....	13
2.3.3 Front Panel Controls .....	13
2.3.4 Rear Panel.....	15
2.3.5 Rack Mount.....	17
2.3.6 Technical Specifications .....	18
2.4 Showmaster Pro Description.....	21
2.4.1 Contents of the Package.....	21
2.4.2 First Start.....	21
2.4.3 Front Panel Controls .....	21
2.4.4 Rear Panel .....	26
2.4.5 Rack Mount.....	30
2.4.6 Technical Specifications .....	30
2.5 Showmaster Go Description.....	34
2.5.1 Contents of the Package.....	34
2.5.2 Getting Started .....	35

2.5.3 Front Panel.....	35
2.5.4 Rear Panel.....	35
2.5.5 Mounting.....	36
2.5.6 Technical Specifications.....	36
2.5.7 Environment.....	37
2.5.8 Maintenance.....	38
2.6 Disposal Information: All Showmaster Devices.....	39
<b>3 Showmaster Maintenance.....</b>	<b>41</b>
3.1 Showmaster Firmware.....	41
3.1.1 Firmware Package.....	41
3.1.2 Firmware Installation.....	41
3.1.3 Create Custom Firmware.....	43
3.1.4 Update Showmaster V2 Firmware.....	47
3.1.5 Reset Showmaster Firmware.....	49
3.2 Recovery Tools.....	50
3.2.1 Recovery Mode.....	50
3.2.2 Recovery Tool Console.....	51
3.2.3 Test Mode Commands.....	58
3.3 Showmaster Logs.....	64
3.3.1 Manage Logs Windows.....	64
3.3.2 Notify Messages.....	66
3.3.3 Alarm Messages.....	66
3.3.4 Error Messages.....	66
3.3.5 Fatal Messages.....	67
3.4 Showmaster Troubleshootings.....	68
3.4.1 Showmaster.....	68
3.4.2 Showmaster Editor V2.....	69
<b>Contact Us.....</b>	<b>70</b>

# 1 About this Manual

---

This manual is written for professional users: show technicians, freelancers and end user technicians who are responsible for installing and running Medialon Showmaster show controllers in live events or permanent installations.

## **Important: please read:**

- M562 Medialon Safety Instructions for installation, use and service
- M561 End User's License Agreement for Medialon Software and Plug-Ins. Warranty Terms and Conditions for Medialon Hardware

## **For Medialon show control software, please refer to:**

- M515 Medialon Control Systems Manual

## 1.1 Prerequisites

---

This manual assumes the following prerequisites:

- Proficiency using Windows interface
- General knowledge of computer hardware
- General knowledge of control protocols: DMX 512, MIDI, Serial, Timecode
- General knowledge in audio-visual: Video, Video processing, Audio, Lighting, Machinery
- General knowledge in show structure

## 1.2 Objective of this Manual

---

After reading this manual, you will be able to:

- Describe the features of Medialon show control hardware
- Set up hardware required for a Show Control installation using Medialon show control hardware

# 2 Showmaster Overview

## 2.1 Embedded Show Controllers

Medialon Control System brings the power of Medialon Manager, award-winning Show Control software, in a rugged and compact hardware design.

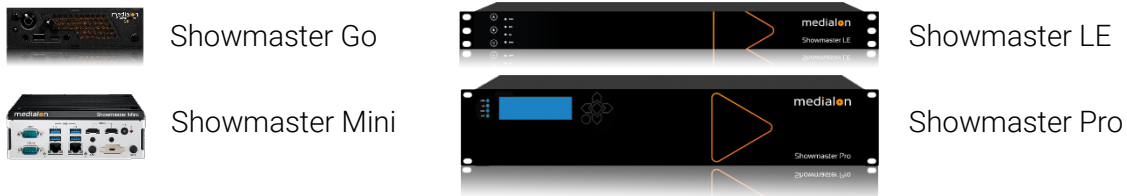

The Showmaster range includes products that are managed in different ways. Showmaster LE and Showmaster Pro use a free programming software called Showmaster Editor to build and edit shows, debug project operation and performance, and manage the hardware. Showmaster Mini and Showmaster Go run Medialon Manager on the Showmaster hardware. Programming is done directly on the Showmaster Mini or Showmaster Go hardware. This is a key difference.

	Programming Software	Number of Timelines	Number of WebPanel Connections	Number of Devices
<b>Showmaster Mini</b>	Medialon Manager for Showmaster Mini	0	1	20, upgradable in batches of 10 to max of 50
<b>Showmaster LE</b>	Showmaster Editor	1	3	Recommended max 150
<b>Showmaster Pro</b>	Showmaster Editor	Unlimited	10	Recommended max 300
<b>Showmaster Go</b>	Medialon Manager Lite or Pro	1 or Unlimited	2 or 10, upgradable in batches of 10	Recommended max 150

The free Showmaster Editor software embeds most of the features of the award-winning Medialon Manager software such as synchronization and logical programming as well as real time testing.

Showmaster LE and Showmaster Pro use a run-time version of Medialon Manager software. A timeline show is created by connecting a computer / laptop to Showmaster via Ethernet, authoring the project, then transferring the finalized file. During authoring, Medialon Showmaster passes through commands to attached AV devices, allowing easy checking of show programming as it is being created.



Medialon Showmaster benefits from the extensive Medialon device plug-in library for connectivity with a wide range of audio-visual equipment.

Showmaster V2 projects are created and controlled at production time using a laptop or other computer connected to the Showmaster via the Ethernet interface; the programming computer runs Medialon Showmaster Editor V2 software. Once the project has been created, it is transferred to Showmaster V2 for playback.

## Showmaster Mini

Showmaster Mini is a capable and flexible device is suited to simple AV control applications and installation types. Its ruggedized, fanless, small form factor makes it easy to mount where AV racks are not suitable. Showmaster Mini carries a reduced-feature version of Medialon Manager show control software, making it a low-cost solution that still carries the power, flexibility, and ease of use Medialon is known for. Designed for less demanding applications, it starts with a 20-device limitation, expandable in 10-device batches up to a max of 50 devices. This AV device controller runs Medialon Manager V6 and V7 for Showmaster Mini for step-based tasks only.



The connectors for Showmaster Mini are all on the front of the unit, as it is meant to be mounted vertically on a DIN rail. It includes two Serial ports, four USB 3.0 ports, two HDMI ports (for Local Panels and programming), two 10/100/1000 Base-T Ethernet ports, and the power button.

Showmaster Mini runs Windows 10 IoT Enterprise LTSC and includes Medialon Manager for Showmaster Mini software for programming and show execution.

## Showmaster LE

Showmaster LE is an all-in-one Embedded Show Controller fitted with all necessary show protocol interfaces. It controls and synchronizes dimmers, lighting desks, video projectors, video servers, sound processors etc. Showmaster LE also provides digital I/O.

Its free editing software, Showmaster Editor V2, embeds most of the features of our award-winning technology such as devices synchronization and logical programming as well as real time testing. It allows programming of one show at a time, up to 3 Webpanels but does not support 3rd party extension interfaces.

Medialon Showmaster LE is a 1 U, full 19" rack-mountable machine; the front panel consists of function buttons and status LEDs.



The rear panel hosts two 10/100/1000 Base-T Ethernet interfaces, digital I/O connections, serial ports, a DMX port, and MIDI ports.



Medialon Showmaster LE operates on an embedded operating system (OS) and is programmed with Showmaster Editor software.

## Showmaster Pro

Showmaster Pro is an all-in-one embedded Show Controller fitted with all necessary show protocol interfaces. It controls and synchronizes dimmers, lighting desks, video projectors, video servers, sound processors etc. Showmaster Pro also provides digital I/O and balanced timecode input/output with video ref.

Its free editing software, Showmaster V2, embeds most of the features of our award-winning technology such as devices synchronization and logical programming as well as real time testing. It supports multiple timeline, 3rd party interfaces, up to 10 WebPanel and signal recording.

Medialon Showmaster Pro is a 2U, full 19" rack-mountable machine; the front panel consists of an LCD display, function buttons and status LEDs. (Mk 2 illustrated).





The rear panel hosts two 10/100/1000 Base-T Ethernet interfaces, digital I/O, serial ports, DMX ports, MIDI ports and timecode input and output ports.



Medialon Showmaster Pro operates on an embedded operating system (OS) and is programmed with Showmaster Editor software.

## Showmaster Go

Showmaster Go is the top of the line Medialon show control product, running Medialon Manager V6 and V7 software and MAS Pro Dante software on the same compact, ruggedized hardware. It is intended to be mounted on things that move: ride vehicles, parade floats, tour busses, trams, show barges, etc.

It can be mounted in a 1U rack mount (three can fit side by side in 1U of rack space), or it can be mounted in a shock mount carrier for high vibration/high shock environments. The front panel includes the power button, a USB 2.0 type A connector, and a USB 3.0 type C connector.



The rear panel has four DisplayPort outputs (for Local Panels), a GPIO port with 3 software-configurable channels of Input or Output, two 10/100/1000 Base-T Ethernet ports, and two USB 2.0 type A ports.



Showmaster Go runs Windows 10 IoT Enterprise LTSC and includes Medialon Manager (Lite or Pro, depending on licensing) and MAS Pro software (licensed for 16, 32 or 64 channels of Dante output).

## 2.1.1 Showmaster Architecture

The remainder of this section is specific to the Showmaster Pro and Showmaster LE architecture, since it differs from Medialon Manager, documented elsewhere in this manual. The following sections only apply to Showmaster LE and Showmaster Pro.

## 2.1.2 Medialon Showmaster Modes

Showmaster LE/Pro switches between different modes to run, program and maintain it.

### Running or Normal Mode

This is the default mode of Medialon Showmaster LE/Pro. At startup, Showmaster LE/Pro uses its locally connected resources and runs the show.

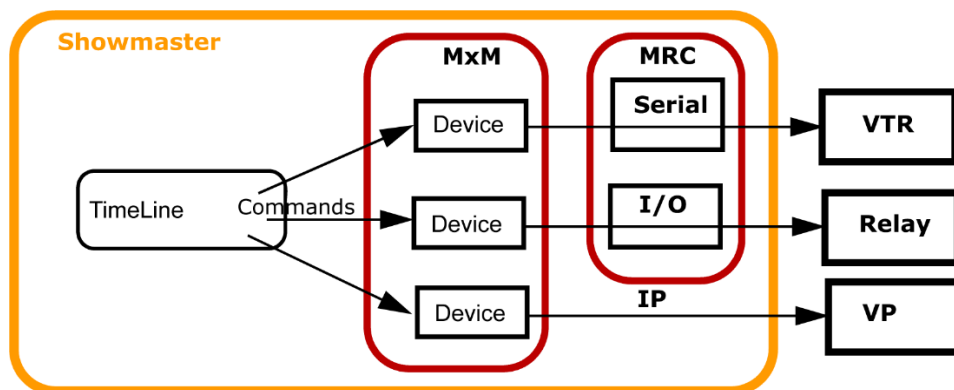

- Device Commands are executed when the Timeline runs.
- The Devices send command orders using a Medialon plug-in (MxM) through the appropriate resources (MRC) to connected machines.

### Programming Mode

When Showmaster LE/Pro is connected to a Showmaster Editor V2, the show runs in Showmaster Editor V2 for easy editing and programming.

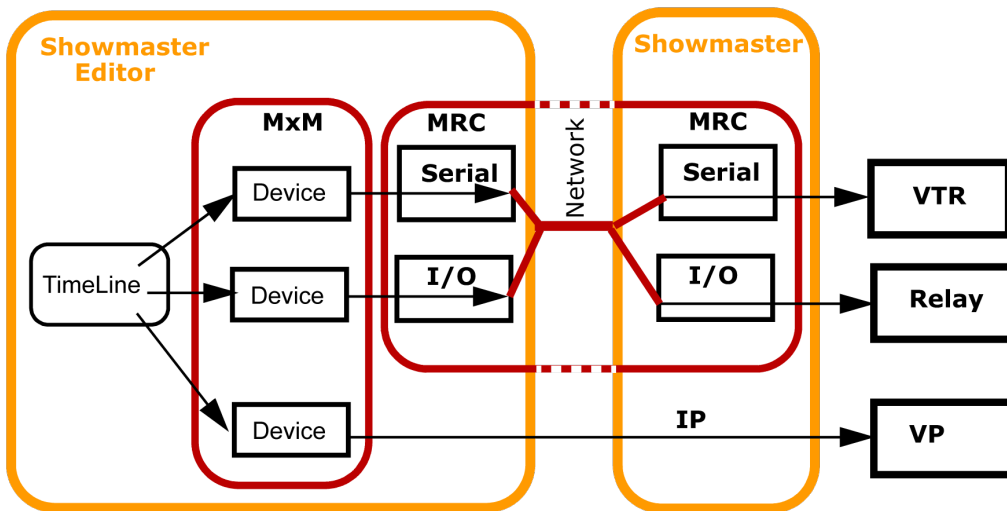

Showmaster Editor V2 uses Showmaster’s local resources to communicate with the devices.

## Recovery Mode

This mode is used for low-level operations. Medialon Showmaster LE/Pro switches to recovery mode when a front panel button is held during startup (details in each model’s section).

A computer connected to Showmaster’s Serial Port 1 or via a network connection can access Showmaster using Medialon Control System Recovery Tool.

### 2.1.3 Recovery Tool

Medialon Showmaster Recovery Tool can be used when a Showmaster LE/Pro is started in Recovery Mode. Your computer can be connected to the Showmaster using a serial communication cable plugged into the Showmaster’s serial port 1. It is also possible to use a network connection to establish the communication.

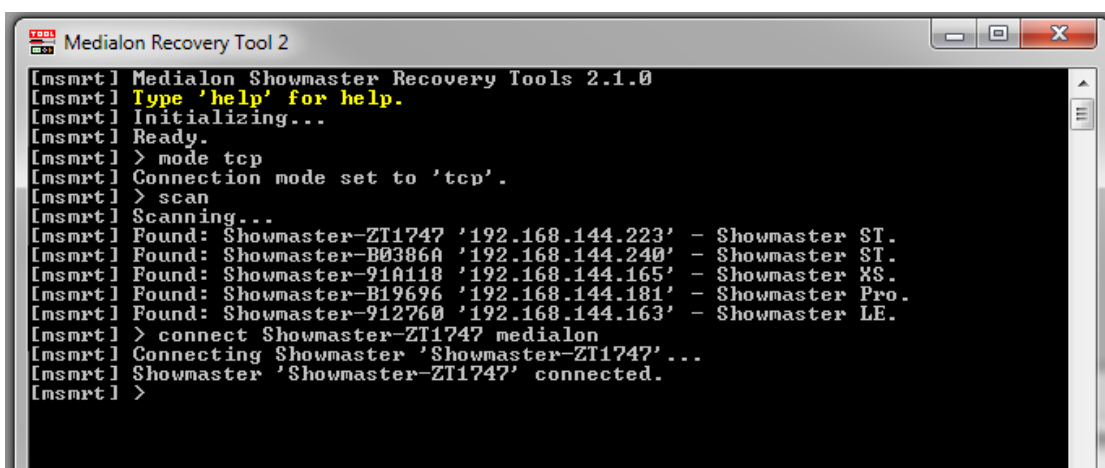

This toolset allows the user to:

- Delete the Current Project and Log Files

- Make configuration changes
- Test connected resources
- Reset to the default factory configuration

## 2.2 Showmaster Mini Description

---

### 2.2.1 Contents of the Package

The Medialon Showmaster Mini Package includes:

- Medialon Showmaster Mini
- Power adaptor

### 2.2.2 Getting Started

Showmaster Mini runs a version of Medialon Manager, and programming can be done directly on the hardware.

### 2.2.3 Front Panel Controls



#### Power button

🔌 Press to power on Showmaster Mini. The orange LED indicates the power state.

- 2 × Serial, COM 1 and COM 2
- 4 × USB 3.0
- 2 × RJ45 10/100/1000 base-T Ethernet
- 2 × HDMI UHD

### 2.2.4 Side Panel

The image below shows the side panel of Medialon Showmaster Mini. This has the Phoenix DC power connector and 3.5 mm mini-jack sockets for line out and mic in.



## 2.2.5 Mounting

The rear panel has 3 screw points for attaching a DIN-rail bracket for vertical mounting. Alternatively, the unit can be wall mounted using two correct brackets, attached to left and right sides at the lower two screw points on each side.

## 2.2.6 Technical Specifications

USB ports	4 × USB 3.0
Serial ports	2 × RS232
Video output	2 × HDMI UHD
Audio	1 × mic in, 1 × line out, 3.5 mm mini jack
Ethernet	2 × 10/100/1000 base-T
Storage	238 GB SSD
Power connection	12-28 VDC 60 W (3 pin Phoenix connector)
Power consumption	7.6 W typical, 19 W max.
Mounting options	DIN-rail/Wall Mount
Dimensions (W × D × H)	158 mm × 114 mm × 53.5 mm (6-1/4" × 4-1/2" × 2-1/8")
Weight	1.2 kg (2.65 lbs)

Technical specifications are subject to change without prior notice. Please check [www.medialon.com](http://www.medialon.com) for the latest information.

## Environmental Specifications

### Operating Temperature

- With industrial-grade SSD/mSATA: -30 ~ 70 °C (22 ~ 158 °F), with airflow rate = 0.7 m/sec
- With 2.5-inch hard disk: 0 ~ 45 °C (32 ~ 113 °F), with airflow rate = 0.7 m/sec

### Relative Humidity

- 95% @ 40 °C (non-condensing)

### **Storage Temperature**

- -40 ~ 85 °C (-40 ~ 185 °F)

### **Vibration Tolerance**

- When the system is equipped with an SSD/mSATA: 3 Grms, IEC 60068-2-64, random, 5 ~ 500 Hz, 1 hr/axis, (x, y, z) 3 axes

### **Shock Tolerance**

- When the system is equipped with an SSD/mSATA: 30 G, IEC 60068-2-27, half sine, 11 ms duration

### **Safety Certification**

- UL, CB, CCC, BSMI

### **EMC Certification**

- CE, FCC, CCC, BSMI

### **Federal Communications Commission (FCC Statement)**

This equipment has been tested and found to comply with the limits for a Class B digital device, pursuant to part 15 of the FCC Rules. These limits are designed to provide reasonable protection against harmful interference in residential installations. This equipment generates, uses, and can radiate radio frequency energy and, if not installed and used in accordance with the instructions, may cause harmful interference to radio communications. However, there is no guarantee that interference will not occur in a particular installation. If this equipment does cause harmful interference to radio or television reception, which can be determined by turning the equipment off and on, users are encouraged to try to correct the interference by one or more of the following measures:

- Reorient or relocate the receiving antenna.
- Increase the separation between the equipment and receiver.
- Connect the equipment into an outlet on a circuit different from that to which the receiver is connected.
- Consult your dealer or an experienced radio/TV technician for help.

For further technical information, please refer to the Advantech ARK-1220L user manual.

## 2.3 Showmaster LE Description

---

### 2.3.1 Contents of the Package

The Medialon Showmaster LE Package includes:

- Medialon Showmaster LE
- Power adaptor

### 2.3.2 Getting Started

Medialon Showmaster LE is designed as a stand-alone Show Controller.

Showmaster LE does not need a keyboard, mouse or screen to work.



Connect the power supply and press and hold the front  key to start Showmaster LE.

### 2.3.3 Front Panel Controls

#### Key Functions

##### A key

Holding this key during Startup will start the Showmaster in Recovery Mode. See also [Recovery Mode](#).

##### B key

Hold this key for more than 5 seconds to close all Showmaster client connections (to Editor or Manager). Showmaster returns to Running mode.



The B key does not close client connections when Showmaster is in Recovery mode.

##### Power key



Press this key to power on Showmaster.

Press this key to power off (soft power) Medialon Showmaster.

## LED Status Messages

Four LEDs give a quick overview of the main status of Medialon Showmaster.

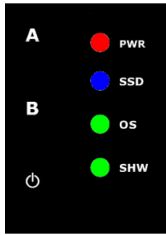

### PWR: Power LED

This LED lights red when Showmaster is powered on.

### SSD: SSD LED





















This LED blinks blue when Showmaster is reading or writing to its internal storage.

### OS: Showmaster LED











This LED indicates the current status of Medialon Showmaster.

### SHW: Project LED

This LED indicates the current status of the Medialon Showmaster Project.

Status	OS	SHW
Default (Not Ready) State	OFF 	OFF 
Showmaster Starting Up / Shutting Down	Blink 	OFF 
Showmaster Ready (OS)	ON 	OFF 
Showmaster Project Starting	ON 	Blink 
Showmaster in Running Mode	ON 	ON 
Showmaster in Programming Mode	ON 	Blink Slow 
Showmaster switching Mode	ON 	Blink Fast 
Waiting Recovery Confirmation		Alternate Blink Fast 
Recovery Mode	ON 	Pulse 
License Missing		Alternate Blink 
Showmaster Fault	Still/Drop 	Blink Fast 



Status	OS	SHW
Resources Missing	Still/Drop 	Still/Drop 
Project Alert	ON 	Still/Drop 
Loading Project Error	ON 	Flashing 
<b>Since Showmaster Firmware 2.2.0</b>		
Showmaster Storage Fault	Pulse 	ON 
IP Address Conflict Detected	Pulse x3 	ON 

## 2.3.4 Rear Panel

The image below shows the rear panel of Medialon Showmaster LE.



- [LAN] RJ45 Ethernet LAN connectors (10/100/1000 Base-T)
- [USB]: Not used (\*)
- [Serial 1] Serial Port 1: Serial RS232 port
- [Serial 2] Serial Port 2: Serial RS232 port
- [MIDI] MIDI Port: MIDI Input and Output
- [DMX512] DMX Port: DMX512 Output
- [Relay Outputs] Digital Output Port: 4 relays 24 V 1 A Max
- [Digital Inputs] Digital Input Port: 4 contact closure input detection max 10 kΩ
- [POWER] Power Connector 12 VDC 5 A. [See Power section for details.](#)

(\*) USB bottom port may be used for maintenance purposes (such as image updates/restoration), top port is not used.

## Digital Input/Output Port Wiring

### Digital Input Connector

Showmaster LE has four digital (contact closure) inputs.

Digital Inputs are connected to Showmaster LE via terminal block connectors.

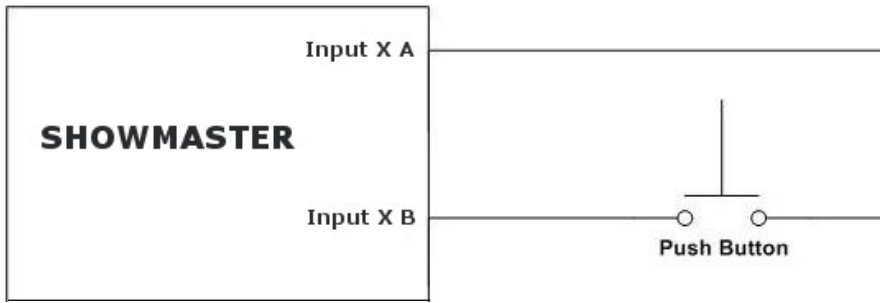

### Relay Output Connector

Showmaster LE has four relays. Relay outputs are connected to Showmaster LE via 4 terminal block connectors.

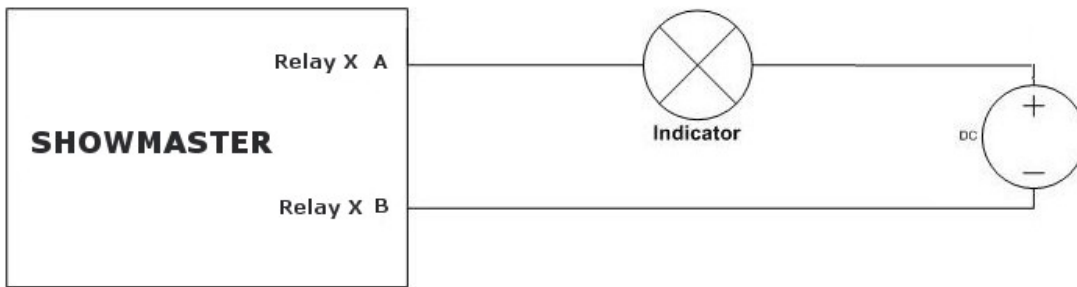

### MIDI Connection

Medialon Showmaster LE is provided with MIDI Input and Output port.

#### Pin Connection

- 1 NC
- 2 NC
- 3 Cable shield (output only)
- 4 +5 V DC (source)
- 5 MIDI Data (sink)

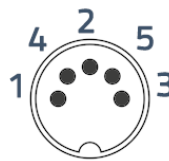

### DMX Connection

Medialon Showmaster LE is provided with a DMX 512 output.

**Pin Connection**

1	Ground
2	Data -
3	Data +
4	NC
5	NC



**Serial Connection**

Medialon Showmaster LE is provided with 2 serial ports.

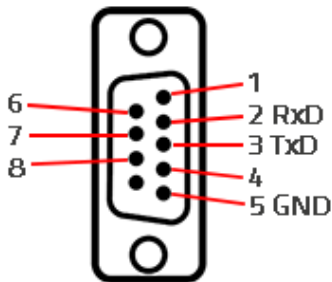

Showmaster LE is configured with DTE serial ports. Use a crossover (null modem) cable when you want to connect to a computer.

**2.3.5 Rack Mount**

WARNING – The unit is intended to be rack mounted as per applicable requirements so no imbalance likely to occur to the internal components. Adequate clearance for airflow should be provided on both sides so ambient temperature does not exceed the limit.

- Please refer to document: **M562 Medialon Safety Instructions** for installation, use and service.

**Installation**

NOTE You need a #2 Phillips screwdriver for rack mount installation. Complete the following steps to mount devices in a rack:

- Remove the rack mount kit from the shipping carton. The kit contains two L-shaped mounting brackets and four sink-head screws.
- Using a Phillips screwdriver, attach the mounting brackets to the sides of the device using four sink-head screws.
- Using a Phillips screwdriver, mount the device in the rack using four rack-mounting screws.

## 2.3.6 Technical Specifications

### Network Connection

- Number: 2
- Connector: RJ45 female
- Interface: 10/100/1000 Mbps (1000 Base-T)
- Protocol: TCP/IP
- Addressing: Static IP or DHCP

### USB Connections

- Number: 2
- Connector: USB slave socket
- Interface: USB 2.0
- USB Top Port: Not Used
- USB Bottom Port: May be used for maintenance purposes (such as image updates/restoration)

### Serial Interfaces

- Number: 2
- Connector: 9-pin D-type Male
- Format: RS-232

### Digital Interfaces

Isolated Inputs:

- Number: 4
- Mode: Contact closure
- Connector: terminal block

Relay Outputs:

- Number: 4 Relays
- Contact Type: Dry Contact
- Max. Switching Voltage: 24 V DC
- Max. Switching Current: 1 A
- Connector: terminal block

## DMX Interface

- *Number:* 1 DMX512 Output
- *Connector:* XLR 5 pin - type Female

## MIDI Interface

1 MIDI Output / 1 MIDI Input

- *Connector:* MIDI DIN 5 pin - type Male

## Physical

- *Size Rack Mount (W × D × H):* 18.75 × 10.25 × 1.75" (476 × 260 × 44.5 mm)
- *Size Stand-alone (W × D × H):* 17.38 × 10.25 × 1.75" (441 × 260 × 44.5 mm)
- *Weight:* 11 lbs (5 kg)
- *Operating Temperature:* 32°F – 104°F (0°C – 40°C)
- *Storage Temperature:* -4°F – 185°F (-20°C – 85°C)
- *Operating Humidity:* 10 – 80% RH Non-condensing
- *Storage Humidity:* 5 – 90% RH Non-condensing
- *Operating Altitude:* sea level to 2000 meters.

## Power

- External Power Adapter EDACPOWER ELEC
- Model EA10683N-120
- AC Input 100-240 V – 2.0 A, 50-60 Hz
- DC Output 12 V DC 5 A
- Connector: DC-Jack

## Approvals

- FCC 47 CFR Part 15 Subpart B
- ICES-003 Canada
- EN 55032
- IEC 61000-3-2 and IEC 61000-3-3
- EN 55024
- IEC-61000-4-2 and IEC-61000-4-3 and IEC-61000-4-4 and IEC-61000-4-5 and IEC-61000-4-6 and IEC- 61000-4-11

- IEC/EN/UL 62368-1
- CSA C22.2#62368-1
- IEC 60950-1

### **Federal Communications Commission (FCC Statement)**

This equipment has been tested and found to comply with the limits for a class A digital device, pursuant to Part 15 of the FCC rules. These limits are designed to provide reasonable protection against harmful interference when the equipment is operated in a commercial environment. This equipment generates, uses, and can radiate radio frequency energy, and if not installed and used in accordance with the instruction manual, may cause harmful interference to radio communications. Operation of this equipment in a residential area may cause harmful interference, in which case the user will be responsible for correcting any interference at his own expense

Changes or modifications not expressly approved by the party responsible for compliance could void the user's authority to operate the equipment

FCC responsible:

7thSense Design Ltd  
4207 Vineland Rd.  
Suite M1  
Orlando, FL 32811  
USA

T: +1 407 505 5200

### **EMC notices**

EN55032/CISPR32 Class A MME (MultiMedia Equipment)

**Warning:** This equipment is compliant with Class A of CISPR 32. In a residential environment this equipment may cause radio interference.

GB/T 9254 Class A ITE (Information Technology Equipment)

**Warning:** This is a Class A product. In a domestic environment this product may cause radio interference in which case the user may be required to take adequate measures.

### **Accessories**

- *Included:* Power Adaptor, Rack Mount Brackets

## 2.4 Showmaster Pro Description

### 2.4.1 Contents of the Package

The Medialon Showmaster Pro Package includes:

- Medialon Showmaster Pro
- Power Supply cord

### 2.4.2 First Start

Medialon Showmaster Pro is designed as a stand-alone Show Controller.



Showmaster V2 Pro does not need a keyboard, mouse or screen to work. Rear power switch must be set on all the time.

Connect the power supply and press and hold the front  key to start the Showmaster. The front panel LCD displays the start-up message.



### 2.4.3 Front Panel Controls

Use the keypad to scroll through Showmaster's status information.



## Keypad Funcions

### OK key



- Hold this key for more than 1 second to power on Showmaster Pro.
- Hold this key for more than 4 seconds while the Showmaster Pro is powered on to reset it.

### Cancel key



- Hold this key for more than 4 seconds to power off (soft power) Showmaster Pro.

### Up arrow



- Scrolls display up.
- Holding this key for more than 1 second scrolls the display to the home position when the button is released.
- Holding this key during Startup will start the Showmaster in Recovery Mode. See also [Recovery Mode](#).

### Down arrow



- Scrolls display down.
- Hold this key for more than 5 seconds to close all Showmaster Pro client connections (to Editor or Manager). Showmaster Pro returns to Running mode.

 This has no effect when Showmaster is in Recovery mode.

### Left arrow



- Not in use.



## Right arrow



- Not in use.

## LCD Display Messages

Each time an arrow button is pressed, the next line of information is displayed.

1. [Name] Showmaster's user-defined Name
2. [Mode] Showmaster's current mode:
  - *Starting Up*: Showmaster Pro is starting up (from power-on until Showmaster Pro is ready)
  - *Running*: Showmaster is running and no Showmaster Editors are connected. Medialon Showmaster also goes to this state when no show file is loaded.
  - *Programming*: A Showmaster Editor V2 is connected to Showmaster and a project is being edited or tested
  - *Run Fault*: the project has caused a runtime error, typically a zero-division error
  - *Recovery*: The Showmaster has been started in Recovery mode
  - *Upd Firmware*: Showmaster V2's firmware is being updated
  - *Downloading*: A Showmaster V2 project is being downloaded from an Editor
  - *Uploading*: The current Showmaster V2 project is being uploaded to an Editor
  - *Factory*: Showmaster is being reset to its factory default state
  - *Shutdown*: Showmaster is shutting down
  - *Reboot*: Showmaster is rebooting
3. [Vers] Showmaster's current firmware version
4. [Proj] Title of the running project (This line is not available when Showmaster is in recovery mode)
5. [Test] When Showmaster is in Recovery Mode, this line indicates the status (On/Off) of the test session
6. [Addr] Current IP address
7. [Mask] Subnet mask
8. [Gway] IP Gateway address
9. [MacA] MAC address

10. [SerN] Serial Number



The lines below are displayed when Showmaster is in Recovery mode:

- 11. [Ser1] Serial port 1 status (Opened/Closed/Failure)
- 12. [Ser2] Serial port 2 status (Opened/Closed/Failure)
- 13. [Ser3] Serial port 3 status (Opened/Closed/Failure)
- 14. [Ser4] Serial port 4 status (Opened/Closed/Failure)
- 15. [Ser5] Serial port 5 status (Opened/Closed/Failure)
- 16. [Ser6] Serial port 6 status (Opened/Closed/Failure)
- 17. [Ser7] Serial port 7 status (Opened/Closed/Failure)
- 18. [Ser8] Serial port 8 status (Opened/Closed/Failure)
- 19. [DMX1] DMX port 1 status (Opened/Closed/Failure)
- 20. [DMX2] DMX port 2 status (Opened/Closed/Failure)
- 21. [MIDI] MIDI port status (Opened/Closed/Failure)
- 22. [Digt] Digital I/O port status (Opened/Closed/Failure)
- 23. [TC] Timecode port status (Opened/Closed/Failure)

## LED Status Messages

Four LEDs give a quick overview of the main status of Medialon Showmaster.



### PWR: Power LED

This LED lights green when power is present, regardless of whether Showmaster is powered on.

### OS: Showmaster Firmware LED

This LED indicates the current status of Medialon Showmaster Firmware.

### SHW: Project LED

This LED indicates the current status of the Medialon Showmaster Project.

### EXT

This indicator turns orange when Medialon Showmaster is in Recovery mode.

Status	OS	SHW	EXT
Default State	OFF 	OFF 	OFF 
Showmaster Starting Up / Shutting Down	ON 	OFF 	OFF 
Showmaster Ready (OS)	ON 	OFF 	OFF 
Showmaster Project Starting	ON 	ON 	OFF 
Showmaster in Running Mode	ON 	ON 	OFF 
Showmaster in Programming Mode	ON 	Blink 	OFF 
Showmaster Switching Mode	ON 	Blink 	OFF 
Waiting Recovery Confirmation	ON 	OFF 	OFF 
Recovery Mode	ON 	ON 	ON 
Showmaster Fault	ON 	ON 	OFF 
Resources Missing	ON 	ON 	OFF 
Project Alert	ON 	Blink 	OFF 
Loading Project Error	ON 	Blink 	OFF 
Log Trace Error	ON 	ON 	ON 
<b>Since Showmaster Firmware 2.2.0</b>			
IP address conflict detected	ON 	ON 	Blink 

## 2.4.4 Rear Panel

The figure below shows the rear panel of Medialon Showmaster Pro Mk 2.



- [USB 1]: Not used
- [USB 2]: Not used
- [LAN 1] RJ45 Ethernet LAN connector (10/100/1000 Base-T)
- [LAN 2] RJ45 Ethernet LAN connector (10/100/1000 Base-T)
- [DMX 1] DMX Port 1: Input / Output DMX512
- [DMX 2] DMX Port 2: Input / Output DMX512
- [MIDI In] MIDI Port: Input MIDI
- [MIDI Out] MIDI Port: Output MIDI
- [Timecode In] Timecode Port: Timecode Input
- [Timecode Out] Timecode Port: Timecode Output
- [Video Ref] BNC Port: Blackburst Video Reference Input
- [Serial 1] Serial Port 1: Serial RS232 port (Serial Port 1 is also used for Recovery Mode)
- [Serial 2] Serial Port 2: Serial RS232 port
- [Serial 3] Serial Port 3: Serial RS232 port
- [Serial 4] Serial Port 4: Serial RS232 port
- [Serial 5] Serial Port 5: Serial RS232 port
- [Serial 6] Serial Port 6: Serial RS232 port
- [Serial 7] Serial Port 7: Serial RS232 port
- [Serial 8] Serial Port 8: Serial RS232 port
- [Relay Outputs] Digital Output Port: 16 Form C electro-mechanical 1A relays
- [Digital Inputs] Digital Input Port: 16 optically isolated inputs
- [POWER] Power Connector 12 V DC 5 A. [See Power section for details.](#)

## Digital Input/Output Port Wiring

### Digital Input Connector

Medialon Showmaster Pro has sixteen optically-isolated inputs that can accept either AC or DC signals and are not polarity sensitive. Input signals are rectified by photocoupler diodes and unused power gets dissipated through a 1.8k-ohm resistor in series. The inputs may be driven by either DC or AC sources of 3 to 31 volts (RMS with frequencies of 40 Hz to 10 kHz). Standard 12/24 volt AC control transformer outputs can be accepted as well. External resistors connected in series may be used to extend the input voltage range, however this will raise the input threshold range.

Isolated Inputs are connected to Showmaster Pro via a SubD 37 pin Male connector.

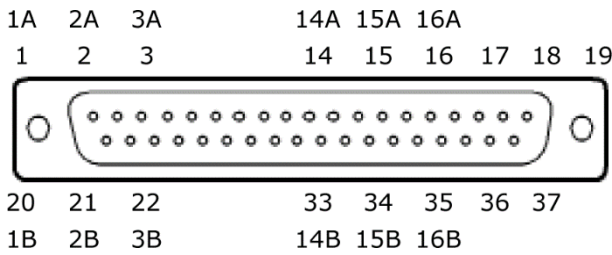
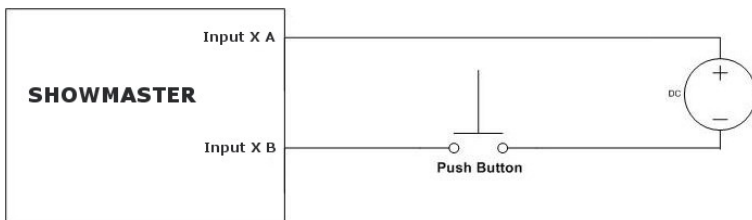

Signal	PIN #
Isolated Input 1A	1
Isolated Input 1B	20
Isolated Input 2A	2
Isolated Input 2B	21
Isolated Input 3A	3
Isolated Input 3B	22
Isolated Input 4A	4
Isolated Input 4B	23
Isolated Input 5A	5
Isolated Input 5B	24
Isolated Input 6A	6
Isolated Input 6B	25

Signal	PIN #
Isolated Input 7A	7
Isolated Input 7B	26
Isolated Input 8A	8
Isolated Input 8B	27
Isolated Input 9A	9
Isolated Input 9B	28
Isolated Input 10A	10
Isolated Input 10B	29
Isolated Input 11A	11
Isolated Input 11B	30
Isolated Input 12A	12
Isolated Input 12B	31

Signal	PIN #
Isolated Input 13A	13
Isolated Input 13B	32
Isolated Input 14A	14
Isolated Input 14B	33
Isolated Input 15A	15
Isolated Input 15B	34
Isolated Input 16A	16
Isolated Input 16B	35
No Connection	17
No Connection	36
No Connection	18
No Connection	19
No Connection	37

## Relay Output Connector

Medialon Showmaster V2 Pro's relay outputs are comprised of sixteen SPST electromechanical relays. All relays are de-energized at power-on.

Relay outputs are connected to Showmaster V2 via a SubD 37 pin Female connector. The wiring may be directly from signal sources or through our optional Breakout Box wiring terminal (SWM\_BO\_KIT). Pin assignments follow.

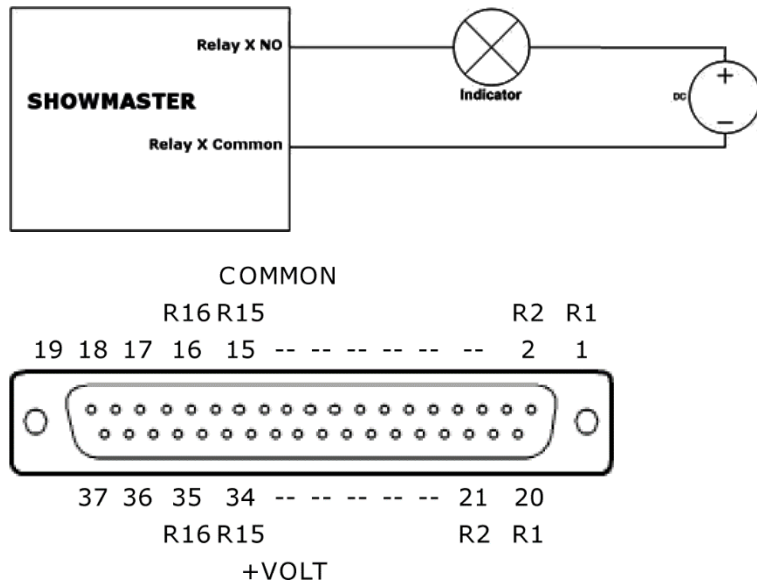

Signal	PIN #
Relay 1 (NO)	20
Relay 1 (Common)	1
Relay 2 (NO)	21
Relay 2 (Common)	2
Relay 3 (NO)	22
Relay 3 (Common)	3
Relay 4 (NO)	23
Relay 4 (Common)	4
Relay 5 (NO)	24
Relay 5 (Common)	5
Relay 6 (NO)	25
Relay 6 (Common)	6

Signal	PIN #
Relay 7 (NO)	26
Relay 7 (Common)	7
Relay 8 (NO)	27
Relay 8 (Common)	8
Relay 9 (NO)	28
Relay 9 (Common)	9
Relay 10 (NO)	29
Relay 10 (Common)	10
Relay 11 (NO)	30
Relay 11 (Common)	11
Relay 12 (NO)	31
Relay 12 (Common)	12

Signal	PIN #
Relay 13 (NO)	32
Relay 13 (Common)	13
Relay 14 (NO)	33
Relay 14 (Common)	14
Relay 15 (NO)	34
Relay 15 (Common)	15
Relay 16 (NO)	35
Relay 16 (Common)	16
No Connection	17
No Connection	18
No Connection	19
No Connection	36
No Connection	37



When using Breakout boxes (SWM\_BO\_KIT), the maximum electrical specifications are 150 mA / 12 V DC per relay with a maximum of 2 A for the whole 16 relays.

## MIDI Connection

Medialon Showmaster Pro is provided with a MIDI input port and a MIDI output. It uses standard MIDI pinouts.

### Pin Connection

- | Pin | Connection                 |
|-----|----------------------------|
| 1   | NC                         |
| 2   | NC                         |
| 3   | Cable shield (output only) |
| 4   | +5 V DC (source)           |
| 5   | MIDI Data (sink)           |

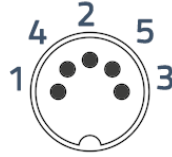

## DMX Connection

Medialon Showmaster Pro is provided with 2 DMX 512 ports that can be used for input or output (software configurable in the Resource Setup).

### Pin Connection

- | Pin | Connection |
|-----|------------|
| 1   | Ground     |
| 2   | Data -     |
| 3   | Data +     |
| 4   | NC         |
| 5   | NC         |



## Timecode Connection

Medialon Showmaster Pro is provided with 1 Timecode balanced input port and 1 Timecode balanced output port.

### Pin Connection

- | Pin | Connection   |
|-----|--------------|
| 1   | Cable shield |
| 2   | Signal +     |
| 3   | Signal -     |



## Serial Connection

Medialon Showmaster V2 Pro is provided with 8 serial ports.

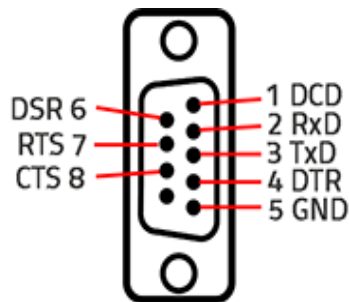

Showmaster Pro is configured with DTE serial ports. Use a crossover (null modem) cable when you want to connect to a computer, for instance to use Medialon Showmaster Recovery Tools.

### 2.4.5 Rack Mount

**WARNING** – The unit is intended to be rack mounted as per applicable requirements so no imbalance of internal components is likely to occur. Adequate airflow clearance is to be provided so ambient temperature does not exceed the limit.

- Please refer to document: **M562 Medialon Safety Instructions** for installation, use and service.

## Installation

**NOTE** You need a #2 Phillips screwdriver for rack mount installation. Complete the following steps to mount devices in a rack:

- Remove the rack mount kit from the shipping carton. The kit contains two L-shaped mounting brackets and four sink-head screws.
- Using a Phillips screwdriver, attach the mounting brackets to the sides of the device using four sink-head screws.
- Using a Phillips screwdriver, mount the device in the rack using four rack-mounting screws.

### 2.4.6 Technical Specifications

#### Network Connection

- Number: 2
- Connector: RJ45 female
- Interface: 10/100/1000 Mbps (1000 BaseT)
- *Protocol*: TCP/IP
- *Addressing*: Static IP or DHCP



## USB Connections

- Number: 2
- Connector: USB slave socket
- Interface: USB 2.0

## Serial Interfaces

- Number: 8
- Connector: 9-pin D-type Male
- Format: RS-232

## Digital Interfaces

Isolated Inputs:

- Number: 16
- Type: Non-polarized, optically isolated inputs (CMOS compatible)
- Voltage Range: 3 to 31 DC or AC RMS (40 – 10,000 Hz)
- Isolation: 500 V channel-to-ground or channel-to-channel
- Input Resistance: 1.8 k $\Omega$  in series with opto-coupler
- Filter Response Times: Rise Time = 4.7 mS / Fall Time = 4.7 mS
- Non-Filter Response Times: Rise Time = 10  $\mu$ S / Fall Time = 30  $\mu$ S
- Connector: Sub-D 37 - type Male

Relay Outputs:

- *Number:* 16 SPDT form C Relays
- *Contact Type:* Single crossbar; Ag with Au clad
- *Rated Load AC:* 0.5 A at 125 V AC (62.5 VA max.)
- *Rated Load DC:* 1 A at 24 V DC (30 W max.)
- Max. Switching Voltage: 125 V AC, 60 V DC
- \*Max. Switching Current: 1 A
- Contact Resistance: 100 m-ohms max.
- *Contact Life:* 5 million operations min.
- Operating Time: 5 mS max.
- Release Time: 5 mS max.
- *Connector:* Sub-D 37 – type Female



When using Breakout boxes (SWM\_BO\_KIT), the maximum electrical specifications are 150 mA / 12 V DC per relay with a maximum of 2 A for the whole 16 relays.

Power Required:

- 5 V@ 30 mA typical (all relays off, add 30 mA per relay)
- 5 V@ 510 mA typical (all relays ON)

## DMX Interface

- *Number:* 2 DMX512 Input or Output
- *Connector:* XLR 5 pin - type Female

## TimeCode Interface

- *Number:* 1 Balanced Timecode Input (Female), 1 Balanced Timecode Output (Male)
- *Connector:* XLR 3 pin
- *Format:* SMPTE

## Video Reference Interface

- *Number:* 1 Blackburst
- *Connector:* Isolated BNC female, 75ohms, Input level .65Vpp to 2.0Vpp (1.0Vpp nominal, ntsc, pal).

## MIDI Interface

- *Number:* 1 MIDI Output / 1 MIDI Input
- *Connector:* MIDI DIN 5 pin - type Female

## Physical

- *Size Rack Mount (W × D × H):* 18.75 × 10.25 × 3.5" (476 × 260 × 89 mm)
- *Size Stand-alone (W × D × H):* 17.38 × 10.25 × 3.5" (441 × 260 × 89 mm)
- *Weight:* 11 lbs (5 kg)
- *Operating Temperature:* 32°F – 104°F (0°C – 40°C)
- *Storage Temperature:* -4°F – 185°F (-20°C – 85°C)
- *Operating Humidity:* 10 – 80% RH Non-condensing
- *Storage Humidity:* 5 – 90% RH Non-condensing
- *Operating Altitude:* sea level to 2000 meters.

## Power

- External Power Adapter EDACPOWER ELEC
- Model EA10683N-120
- AC Input 100-240 V – 2.0 A, 50-60 Hz
- DC Output 12 V DC 5 A
- Connector: DC-Jack

## Approvals

- FCC 47 CFR Part 15 Subpart B
- ICES-003 Canada
- EN 55032
- IEC 61000-3-2 and IEC 61000-3-3
- EN 55024
- IEC-61000-4-2 and IEC-61000-4-3 and IEC-61000-4-4 and IEC-61000-4-5 and IEC-61000-4-6 and IEC- 61000-4-11
- IEC/EN/UL 62368-1
- CSA C22.2#62368-1
- IEC 60950-1

### Federal Communications Commission (FCC Statement)

This equipment has been tested and found to comply with the limits for a class A digital device, pursuant to Part 15 of the FCC rules. These limits are designed to provide reasonable protection against harmful interference when the equipment is operated in a commercial environment. This equipment generates, uses, and can radiate radio frequency energy, and if not installed and used in accordance with the instruction manual, may cause harmful interference to radio communications. Operation of this equipment in a residential area may cause harmful interference, in which case the user will be responsible for correcting any interference at his own expense. Changes or modifications not expressly approved by the party responsible for compliance could void the user's authority to operate the equipment

FCC responsible:

7thSense Design Ltd  
4207 Vineland Rd.  
Suite M1  
Orlando, FL 32811  
USA

T: +1 407 505 5200

## EMC notices

EN55032/CISPR32 Class A MME (MultiMedia Equipment)

**Warning:** This equipment is compliant with Class A of CISPR 32. In a residential environment this equipment may cause radio interference.

GB/T 9254 Class A ITE (Information Technology Equipment)

**Warning:** This is a Class A product. In a domestic environment this product may cause radio interference in which case the user may be required to take adequate measures.

## Accessories

- *Included:* Mains cable, Rack Mount Brackets
- *Options:* SWM\_BO\_KIT Breakout Kit (DB-37 Cable, DIN-Mountable IO Wiring Terminal)

### SWM\_BO Breakout Kit

The SWM\_BO\_KIT Breakout Kit is a terminal block that can be used to break out Showmaster's digital I/O DB37 connectors to screw terminals for easy field termination. The Breakout Kit is designed with both DB37 male and female connectors so it can be used with either the Digital Input or Relay port.



The SWM\_BO Breakout Kit ships with a RoHS compliant terminal block, a DB-37 Male-to-Female cable and two DIN-rail mounting clips.

When using Breakout boxes (SWM\_BO), the maximum electrical specifications are 150 ma / 12 V DC per relay with a maximum of 2 A for the whole 16 relays.

## 2.5 Showmaster Go Description

---

### 2.5.1 Contents of the Package

The Medialon Showmaster Go Package includes:

- Medialon Showmaster Go
- Power adaptor

## 2.5.2 Getting Started

Showmaster Go runs the full Medialon Manager V6 or V7 Lite or Pro software, and programming can be done directly on the hardware.



## 2.5.3 Front Panel

### Power Button and LEDs

🔌 Press to power on Showmaster Go. The white ring light on the power button indicates the power state, as does the orange LED to the left of the power button. A blue LED behind the orange air filter indicates whether the Showmaster Go has power and remains on even when Showmaster Go is powered off.

### Ports

1 × USB 2.0 (Type-A) and 1 × USB 3.1 (Type-C)

### Air Filter

Remove the door and filter, clean or replace the foam tucking it under the left-side screw mount and noting the orientation of the filter. Re-engage the door on the right side, and secure with the screw.

## 2.5.4 Rear Panel

The image below shows the rear panel of Medialon Showmaster Go.



- Kingston safe lock
- 12-19 VDC power inlet with cable inlet clip
- 4 × DisplayPort™ 1.2
- 3 × opto-isolated (0-3.5 V TTL)
- 2 × RJ45 10/100/1000 base-T Ethernet
- 2 × USB 2.0 (Type-A)

## Dual NIC ports

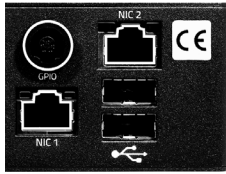

The RJ45 port labelled 'NIC 1' is factory-set to be the Dante network audio output, using DHCP and 'NIC 2' is reserved for show control; NIC 2 is also factory-set to DHCP.

## Digital Input/Output Port Wiring

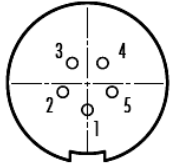

5-pin Binder 420 socket, pin 5 = Vcc

Showmaster Go GPIO cables with fly lead are available from Medialon.

## 2.5.5 Mounting

The Showmaster Go can be mounted singly or in multiples up to three per rack unit. The available mounting options are VESA, an anti-shock mounting frame, and a rack mounting tray. All are available options from Medialon.

When mounting the Showmaster Go, do not block any server air vents, and ensure the ambient temperature around the server is compatible with the environmental characteristics stated.

Particularly when mounted in a rack cabinet with front or rear doors, the ambient temperature around the server may be higher than the ambient room temperature.

Showmaster Go can be mounted vertically using the optional VESA mounting plate or anti-shock frame, but care must be taken that hot air from the rear panel is not drawn back in at the front. Do not mount with the front panel uppermost.

- See document **M555 Mounting the Medialon Showmaster Go** for full details with illustrations.

## 2.5.6 Technical Specifications

USB ports	3 × USB 2.0 (Type-A), 1 × USB 3.1 (Type-C)
Power connection	12-19 VDC, 60 watts max; DC power inlet clip
Ethernet	2 × 10/100/1000 base-T
Video output	4 × DisplayPort™ 1.2
GPIO	3 × opto-isolated (0-3.5 V TTL)
Mounting options	VESA mount; rackmount tray (takes 1-3 units); anti-shock frame;
Kingston Safe Lock	
Dimensions (W × L × H)	145 mm × 152 mm x 44 mm (5-3/4" x 6" x 1-3/4")
Weight	1.4 kg (3 lbs)

Technical specifications are subject to change without prior notice. Please check <https://7thSense.one> for the latest information.

## Approvals and Environmental Information

### Federal Communications Commission (FCC Statement)

This device complies with Part 15 of the FCC Rules. Operation is subject to the following two conditions: (1) this device may not cause harmful interference, and (2) this device must accept any interference received, including interference that may cause undesired operation.

Note: This equipment has been tested and found to comply with the limits for a Class A digital device, pursuant to part 15 of the FCC Rules. These limits are designed to provide reasonable protection against harmful interference when the equipment is operated in a commercial environment. This equipment generates, uses, and can radiate radio frequency energy and, if not installed and used in accordance with this user guide, may cause harmful interference to radio communications. Operation of this equipment in a residential area is likely to cause harmful interference in which case the user will be required to correct the interference at his own expense.

### European Union

This is a Class A product. In a domestic environment, this product may cause radio interference, in which case the user may be required to take adequate measures.

FCC and EU responsible:

7thSense Design Ltd  
4207 Vineland Rd.  
Suite M1  
Orlando, FL 32811  
USA

T: +1 407 505 5200

Please refer to document **M557 Showmaster Go Hardware User Guide** supplied with your unit.

## 2.5.7 Environment

### General

Showmaster Go is intended for use in a commercial (not domestic) environment and should be operated in a clean, dust free area (e.g. a server room).

The unit is intended for operation in benign environments; that is, not subject to corrosive or explosive atmospheres, moisture or flammable gases. The unit is non-protected against ingress of liquid (IPx0). The unit is not designed to be subject to excessive mechanical shock or vibration. For environments with some movement and vibration, an anti-shock frame mount is available for single units.



Only used at altitude  
not exceeding 2000 m



Only used in not-tropical  
climate regions

## Thermal

Do not block any of the unit's air vents and ensure the ambient temperature around the unit is compatible with the environmental characteristics stated on the back page of this manual.

Particularly when mounted in a rack cabinet with front or rear doors the ambient temperature around the unit may be higher than the ambient room temperature.



Showmaster Go can be mounted vertically using the optional VESA mounting plate, but care must be taken that hot air from the rear panel is not drawn back in at the front. Do not mount with the front panel uppermost.

## Electrical

Before connecting mains power to the unit's power supply unit (PSU), ensure the electricity supply is compatible with the electrical ratings shown here and on the power supply product label.



The power supply unit is connected to, and disconnected from, the mains supply with an IEC 60320 power connector.

## 2.5.8 Maintenance

### Air Filter

It is important to remove and clean or replace the filter periodically to avoid overheating. Showmaster Go units are supplied with one spare filter pad, others can be provided by your supplier. Showmaster Go should not be run without filters, since accumulations of dust inside the unit can affect performance.

### Cleaning

External casing and the front panel should be carefully wiped with a soft cloth and antistatic solution.

### Showmaster Go internal maintenance

Showmaster Go contains no user-serviceable parts. For CMOS battery replacement please contact your supplier for further instructions.



**Warning:** Do not operate the unit with any covers removed as the air flow through the unit may be compromised leading to overheating.

Any alterations to the product's specification, including additional/alternative components, BIOS changes, overclocking, etc., may invalidate the warranty or impact the unit's performance. Additionally, such changes or modifications could cause equipment no longer to comply with the



relevant EMC regulations, and void the user's authority to operate the equipment. If in doubt, please contact your supplier.

## 2.6 Disposal Information: All Showmaster Devices

---

### Waste Electrical and Electronic Equipment



**Dispose of the equipment and any components in accordance with all local and national safety and environmental requirements.**



This symbol on the product indicates that, under the European Directive 2012/19/EU governing waste from electrical and electronic equipment, this product must not be disposed of with other municipal waste. Please dispose of your waste equipment by handing it over to a designated collection point for the recycling of waste electrical and electronic equipment. To prevent possible harm to the environment or human health from uncontrolled waste disposal, please separate these items from other types of waste and recycle them responsibly to promote the sustainable reuse of material resources. For more information about recycling of this product, please contact your local city office or your municipal waste disposal service.

### Disposal of batteries in the product



This product contains batteries covered by the European Directive which must be collected and disposed of separately from municipal waste. If the battery contains more than the specified values of lead (Pb), mercury (Hg) or cadmium (Cd), these chemical symbols will appear below the crossed-out wheeled bin symbol. By participating in separate collection of batteries, you will help to ensure proper disposal and to prevent potential negative effects on the environment and human health.

### RoHS compliance

#### Turkey RoHS compliance



Türkiye Cumhuriyeti: AEEE Yönetmeliğine Uygunur [Republic of Türkiye: In conformity with the WEEE Regulation]

## China RoHS Hazardous Substance Table

零件项目(名称) Component Name	有毒有害物质或元素 Hazardous Substances or Elements					
	铅 (Pb)	汞 (Hg)	镉 (Cd)	六价铬 (Cr6+)	多溴联苯 (PBB)	多溴二苯醚 (PBDE)
印制电路配件 Printed Circuit Assemblies	X	O	O	O	O	O
螺帽,螺钉(栓),螺旋(钉),垫圈,紧固件 Nuts, bolts, screws, washers, Fasteners	X	O	O	O	O	O
内部线路 Internal wiring	X	O	O	O	O	O
风扇 Fan	X	O	O	O	O	O
电源供应器 Power Supply Unit	X	O	O	O	O	O
固态硬盘 SSD	X	O	O	O	O	O
<p>这个表被制备按照规定SJ/T 11364 This table is prepared in accordance with the provisions of SJ/T 11364.</p> <p>O: 表示该有毒有害物质在该部件所有均质材料中的含量均在 GB/T 26572 标准规定的限量要求以下。 O: Indicates that this hazardous substance contained in all of the homogeneous materials for this part is below the limit requirement of GB/T 26572.</p> <p>X: 表示该有毒有害物质至少在该部件的某一均质材料中的含量超出 GB/T 26572 标准规定的限量要求。 X: Indicates that this hazardous substance contained in at least one of the homogeneous materials used for this part is above the limit requirement in GB/T 26572.</p>						

# 3 Showmaster Maintenance

---

In this section, you will learn how to maintain your Medialon Showmaster.

## 3.1 Showmaster Firmware

---

The Medialon Showmaster LE/Pro engine is based on Firmware. This is a package of software components that is installed when Medialon Showmaster is built.

Medialon Showmaster’s firmware is based on the same firmware as the Showmaster Editor V2. Each time you want to update your installation, you need to install a new firmware version.

**i** When you work on a project, Medialon strongly recommends using the same firmware version on Showmaster hardware and in Showmaster Editor V2.

### 3.1.1 Firmware Package

Medialon Showmaster firmware mainly consists of:

- Medialon Showmaster’s main core called mShowmasterCore
- Medialon Manager runtime module called ManagerRT
- Medialon Showmaster MRCs
- Medialon Showmaster MxMs

Medialon Showmaster MRCs and MxMs are common to Showmaster hardware and Showmaster Editor V2.

**i** Firmware packages are available for free download. Go to the help menu and select Medialon Internet Resources / Showmaster Firmware Upgrades.

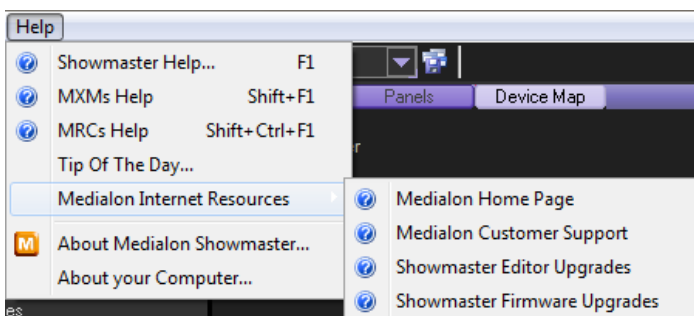

### 3.1.2 Firmware Installation

New versions of Medialon Showmaster firmware must first be installed in Showmaster Editor V2 before Showmaster hardware can be updated.

## Showmaster Maintenance

1. Select Install a Firmware in the File / Firmware management menu of Showmaster Editor V2

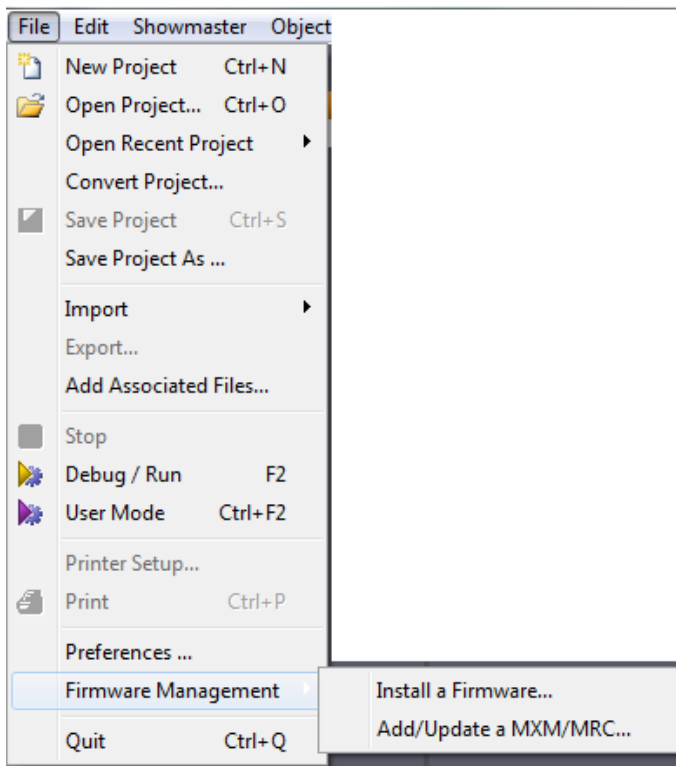

2. The Firmware file browser box opens.

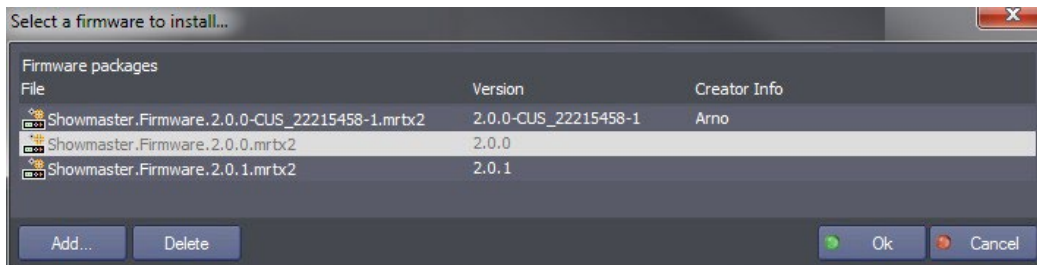

3. Select a firmware in the list
4. Click on Ok to start the Firmware installation.

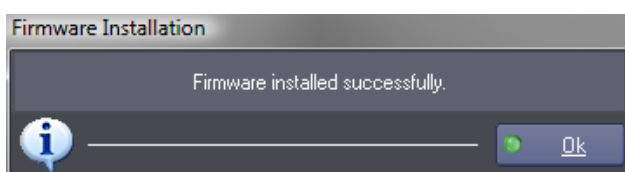
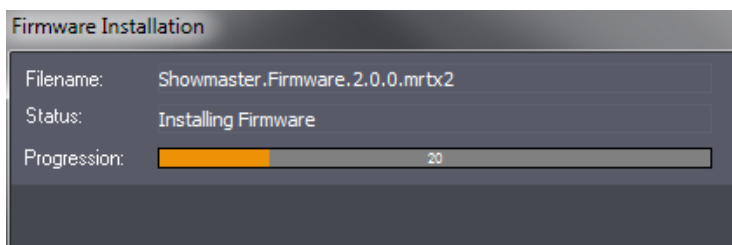

5. Click on OK to complete the installation.

- The new set of MRCs and MxMs is now used by Showmaster Editor V2.
- The current firmware version is displayed in the status bar at the bottom of the Showmaster Editor V2 window.



## Firmware management

From the Firmware Installation window, you can:

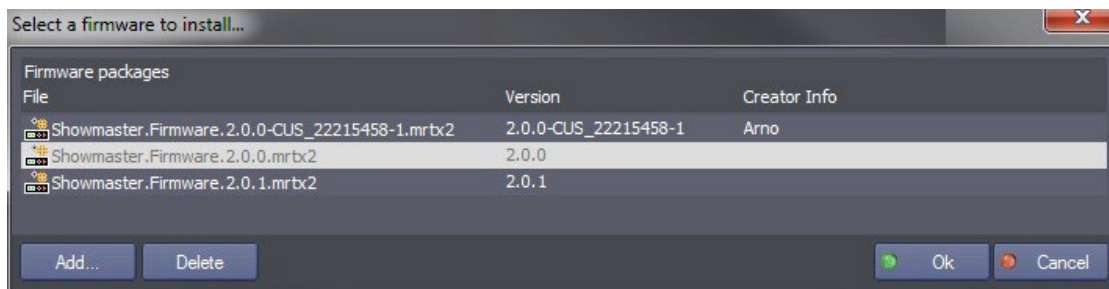

### Add a new firmware



Click on *Add* to browse and find the new firmware file (firmwareXXXX.mrtx2) you want to use in Showmaster Editor V2.

### Delete a firmware

If you want to remove from the firmware list an obsolete firmware, click on *Delete*.

## 3.1.3 Create Custom Firmware

With Showmaster Editor V2 it is now possible to update, add or delete component of Showmaster firmware.

1. Select 'Add/Update a MxM/MRC' in the File / Firmware management menu

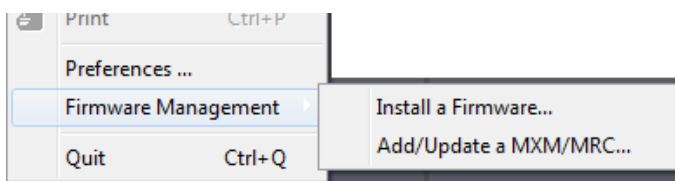

2. The Create Custom Firmware window opens.

## Showmaster Maintenance

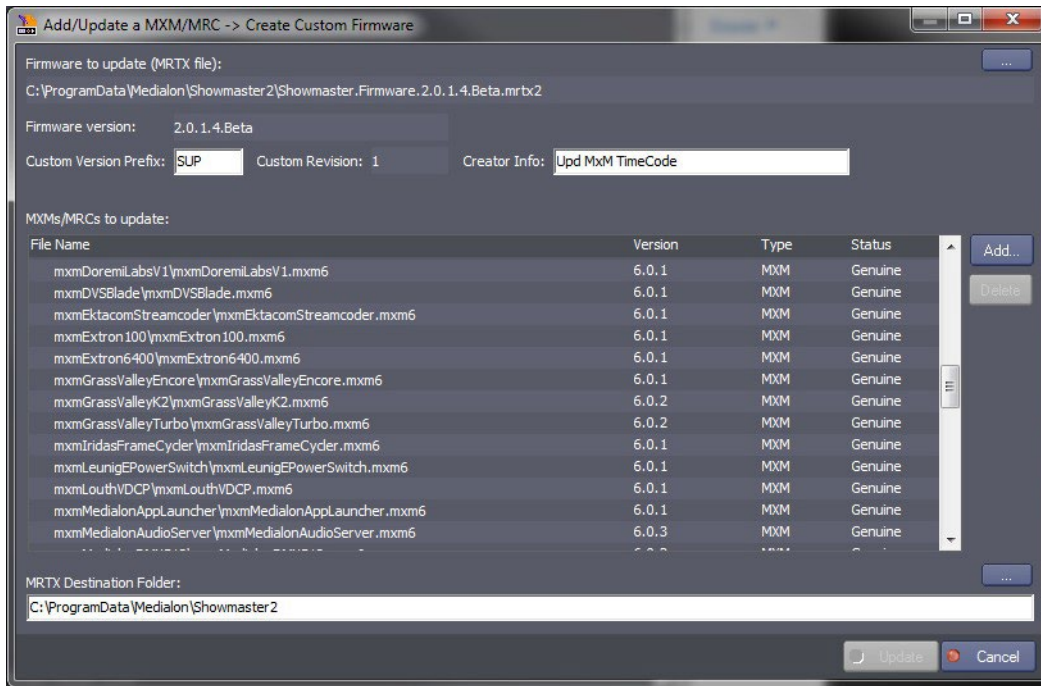

3. Select the firmware you want to update.

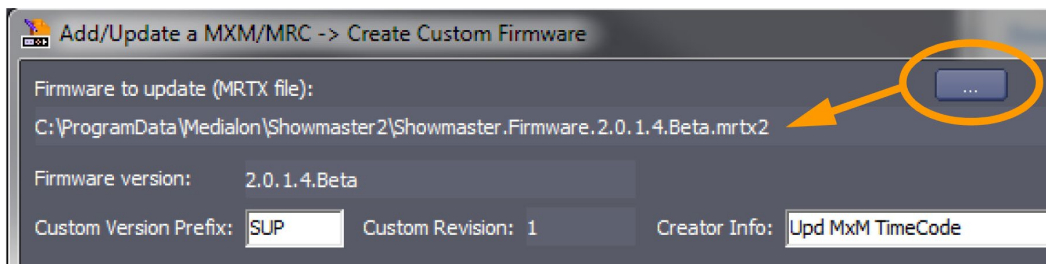

- Use the Browse button [...] to select the firmware file (firmwareXXXX.mrtx2).
- Firmware version gives the current version of loaded firmware.

4. Enter info about the custom firmware you are going to generate.

- *Custom Version Prefix*: enter 3 characters as your identifier in the new firmware generated.
- *Custom Revision* gives the index of the new revision you are creating. If you load a custom firmware, the revision index automatically increases.
- *Creator Info*: enter a comment about this firmware.

5. Select component to add, update or remove

## Showmaster Maintenance

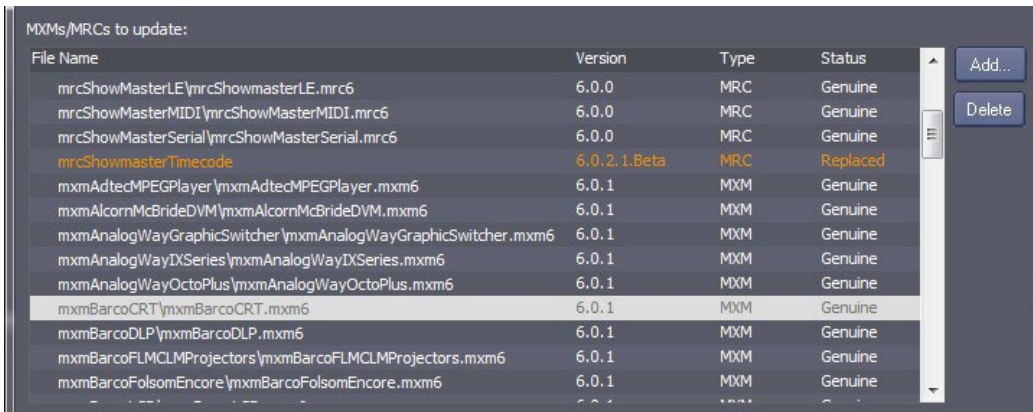

File Name	Version	Type	Status
mrcShowMasterLE\mrcShowmasterLE.mrc6	6.0.0	MRC	Genuine
mrcShowMasterMIDI\mrcShowMasterMIDI.mrc6	6.0.0	MRC	Genuine
mrcShowMasterSerial\mrcShowMasterSerial.mrc6	6.0.0	MRC	Genuine
mrcShowmasterTimecode	6.0.2.1.Beta	MRC	Replaced
mxmAdtecMPEGPlayer\mxmAdtecMPEGPlayer.mxm6	6.0.1	MXM	Genuine
mxmAlcornMcBrideDVM\mxmAlcornMcBrideDVM.mxm6	6.0.1	MXM	Genuine
mxmAnalogWayGraphicSwitcher\mxmAnalogWayGraphicSwitcher.mxm6	6.0.1	MXM	Genuine
mxmAnalogWayIXSeries\mxmAnalogWayIXSeries.mxm6	6.0.1	MXM	Genuine
mxmAnalogWayOctoPlus\mxmAnalogWayOctoPlus.mxm6	6.0.1	MXM	Genuine
mxmBarcoCRT\mxmBarcoCRT.mxm6	6.0.1	MXM	Genuine
mxmBarcoDLP\mxmBarcoDLP.mxm6	6.0.1	MXM	Genuine
mxmBarcoFLMCLMProjectors\mxmBarcoFLMCLMProjectors.mxm6	6.0.1	MXM	Genuine
mxmBarcoFolsomEncore\mxmBarcoFolsomEncore.mxm6	6.0.1	MXM	Genuine

Component status is:

- *Genuine*: part of firmware released by Medialon.
- *Added*: new component.
- *Replaced*: existing component update with a new version.
- *Deleted*: removed component.

## Add/Update

1. Click on Add.. button to open a file browser.

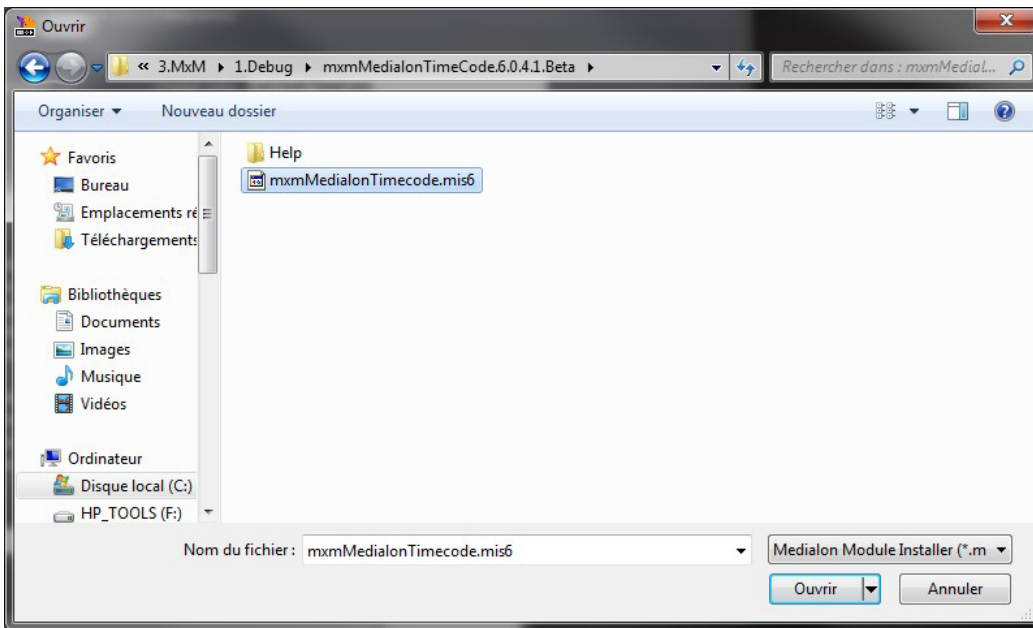

2. Select the MxM or MRC you want to add or update. Depending how you get this new MxM or MRC, you will select
  - Medialon Module Installer (\*.mis6)
  - Module Package (\*.exe)
  - Module Package Archive (\*.zip)

## Showmaster Maintenance

3. If the MxM or MRC is already present in the loaded firmware, a dialog box will ask you to confirm the update.

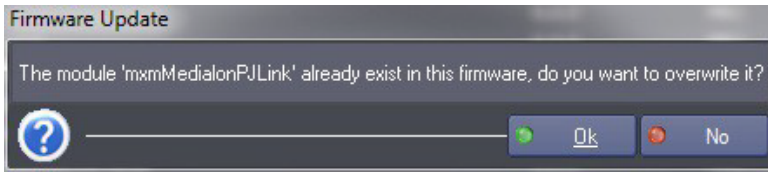

4. MxM or MRC will appear with a new status Replaced or Added.

mrcShowMasterCE\mrcShowMasterCE.mrc6	6.0.0	MRC	Genuine
mrcShowMasterMIDI\mrcShowMasterMIDI.mrc6	6.0.0	MRC	Genuine
mrcShowMasterSerial\mrcShowMasterSerial.mrc6	6.0.0	MRC	Genuine
mrcShowmasterTimecode	6.0.2.1.Beta	MRC	Replaced
mxmAdtecMPEGPlayer\mxmAdtecMPEGPlayer.mxm6	6.0.1	MXM	Genuine
mxmAlcornMcBrideDVM\mxmAlcornMcBrideDVM.mxm6	6.0.1	MXM	Genuine

## Delete

Select an element in the loaded firmware and click on Delete button to remove it.

mxmMedialonIO\mxmMedialonIO.mxm6	6.0.3	MXM	Genuine
mxmMedialonIR\mxmMedialonIR.mxm6	6.0.1	MXM	Remove
mxmMedialonLowLevelCommunicator\mxmMedialonLowLevelCommunicator.mxm6	6.0.2	MXM	Genuine
mxmMedialonMIDI\mxmMedialonMIDI.mxm6	6.0.1	MXM	Genuine

## Save Custom Firmware

1. Select the location where you want to save the new firmware

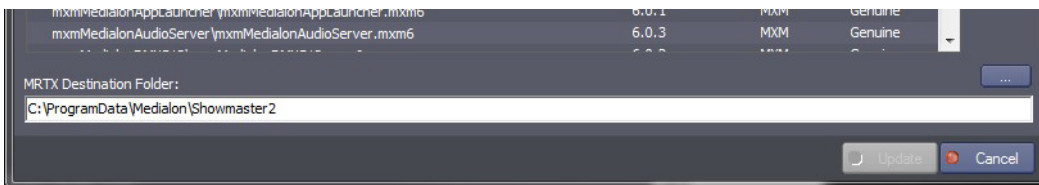

2. Click on OK button to save.

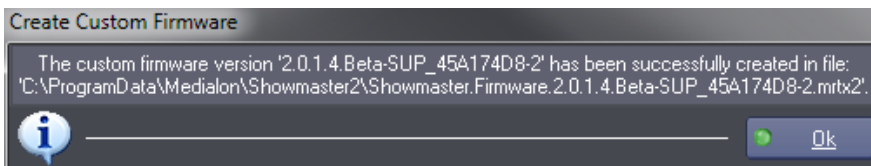

3. When firmware creation is completed, Showmaster Editor V2 will ask if you want to install this new firmware.

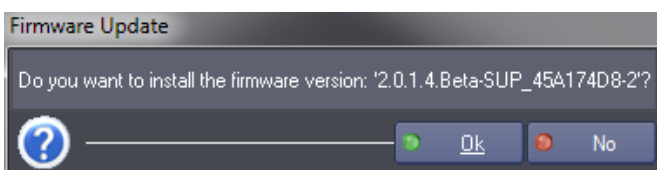



### 3.1.4 Update Showmaster V2 Firmware

Medialon Showmaster’s firmware updates are executed through the Showmaster Editor V2 interface.

#### Updating Firmware

New firmware must be installed in Showmaster Editor V2 before you can proceed to update the firmware in Showmaster.

1. Connect Showmaster Editor V2 to the Showmaster hardware
2. Select update Firmware from the Showmaster menu

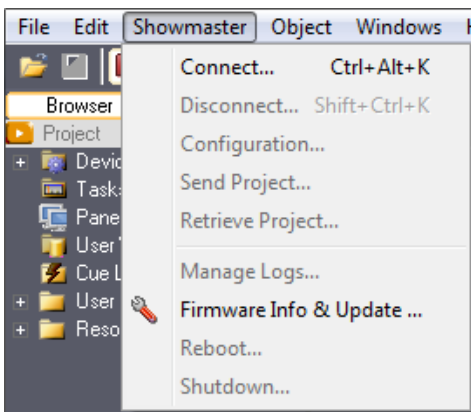

3. The Update Firmware window opens

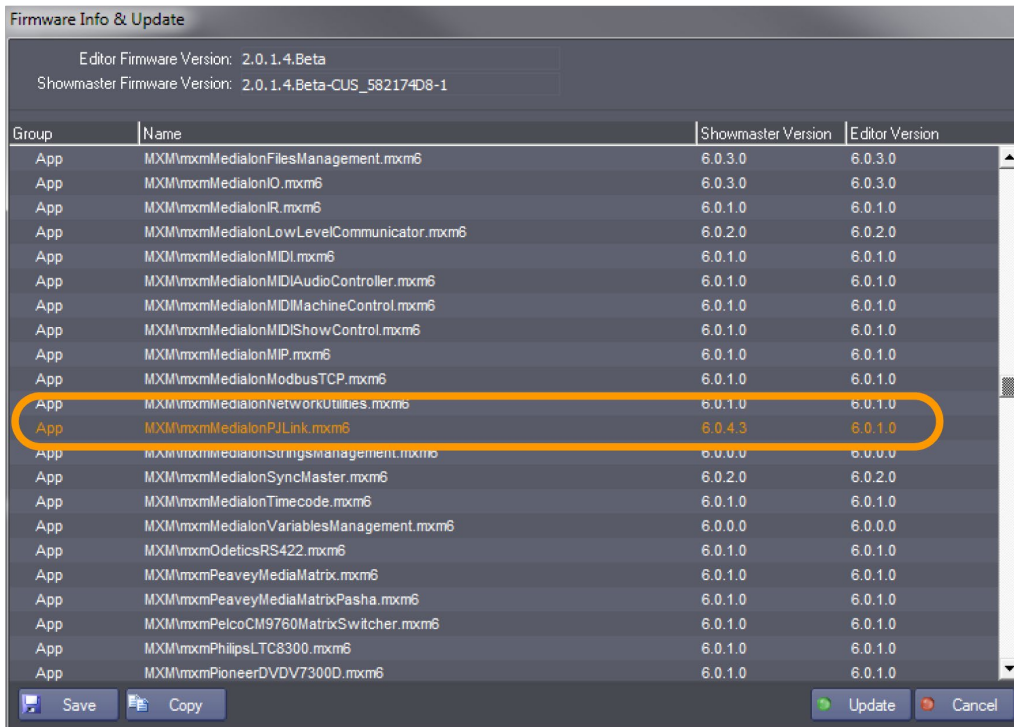

Showmaster Maintenance

4. You can compare the Showmaster hardware's firmware to Showmaster Editor V2's firmware versions. Differences are highlighted with Orange text.
5. Click the Update button to start the Firmware update



The Update button is only active when Showmaster Editor V2's and Showmaster's firmware are different.

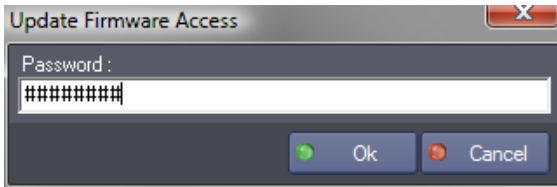

6. Enter your password to confirm the update. Default password is 'medialon'.



The Firmware update password can be changed by the user; Menu Showmaster/Configuration > Passwords. See document M515 Medial Control System Manual for an explanation of the procedure.

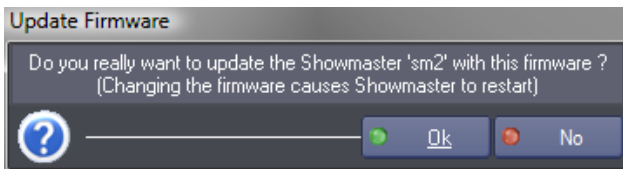

7. Click OK to start the update process

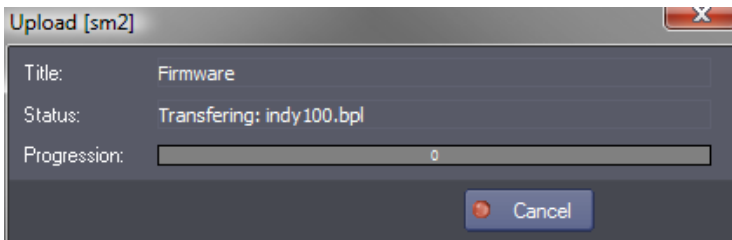

8. The files transfer could take a few minutes

9. Click Close to complete the update

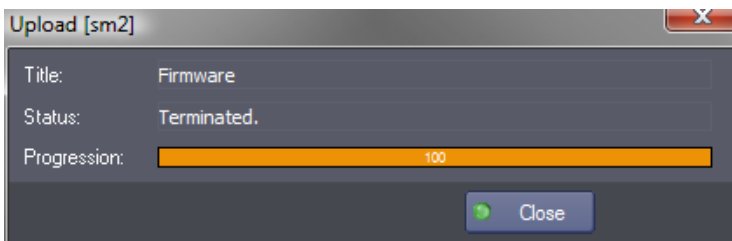

10. The Showmaster hardware needs to restart to complete the firmware update

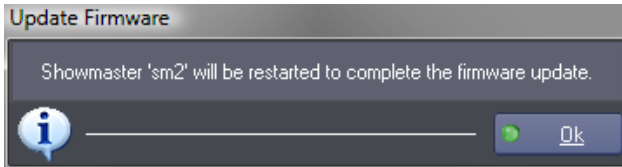

## Firmware Info

If needed or requested by Medialon Support, you can save the list of firmware components.

App	MXM\mxmPeaveyMediaMatrixPasha.mxm6	6.0.1.0
App	MXM\mxmPelcoCM9760MatrixSwitcher.mxm6	6.0.1.0
App	MXM\mxmPhilipsLTC8300.mxm6	6.0.1.0
App	MXM\mxmPioneerDVDV7300D.mxm6	6.0.1.0

Buttons: Save, Copy

- **Save:** save the content list of both firmware (Editor and Showmaster) in an XML file.
- **Copy:** copies to the clipboard the list of components for both firmware. This list can be pasted into an email or a text editor.

### 3.1.5 Reset Showmaster Firmware

It is always possible to reset the Showmaster's firmware to the default factory installation.

Use the 'Factory' command of the Showmaster V2 Recovery Tool as described in the following steps:

1. Start your Medialon Showmaster in Recovery Mode. Hold press Up key during startup process
2. Start Medialon Recovery Tools
3. Type 'scan' to detect your Showmaster on the network
4. Type 'connect' to open the connection with your Showmaster
5. Type 'factory' to initiate the Reset Factory Firmware
6. Type 'commit' to validate and start the reset of Factory Firmware
7. Your Showmaster will reboot at the end of the process



See also [Recovery Tools](#).

## 3.2 Recovery Tools

Medialon Showmaster's Installation CD includes tools to maintain Showmaster.



When a Showmaster is in Recovery Mode, do not switch off or reset the power using the hard switch or the soft buttons on the front. Doing so could corrupt the core engine. To exit from Recovery Mode, restart or shut down Showmaster from the Recovery Tools application. Contact Medialon Technical Support at [support@medialon.com](mailto:support@medialon.com) for more information.

### 3.2.1 Recovery Mode

This mode is used for low-level operations like testing resources or doing a factory reset.



#### Medialon Showmaster Pro

Showmaster Pro switches to recovery mode when the *UP* button is pressed and held during startup. A validation prompt appears on the LCD, asking for validation before entering Recovery Mode.



Confirm by releasing and pressing the *UP* button a second time to activate the Recovery Mode. The LCD panel displays a Recovery Mode message.

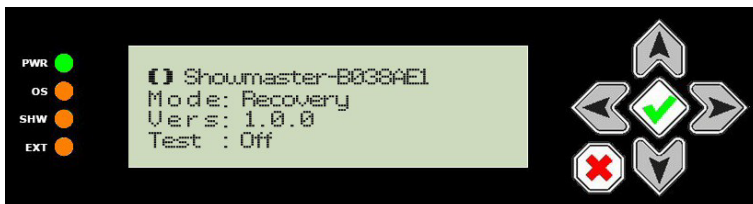

Use direction buttons to display resource status.



A computer connected to Showmaster's Serial Port 1 or via a network connection can access Showmaster using the Medialon Showmaster Recovery Tool console.



## Medialon Showmaster LE

Medialon Showmaster LE switches to recovery mode when the A button is pressed and held during startup. LED for OS and SHW will flash alternately several times.

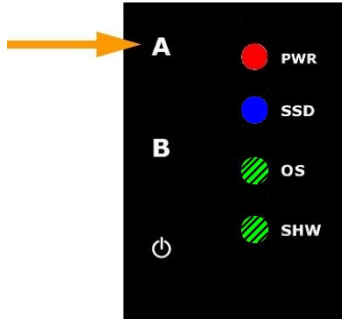

When the OS and Show LEDs start flashing alternately, press the A button a second time to confirm the Recovery Mode.

When SHW LED displays a pulse, Recovery Mode is active.

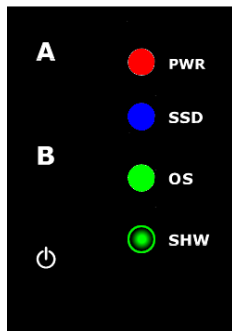

A computer connected to the Showmaster LE's Serial Port 1 or via a network connection can access the Showmaster using the Medialon Showmaster Recovery Tool console.

### 3.2.2 Recovery Tool Console

To launch the Medialon Showmaster Recovery Tool Console, select 'Medialon Showmaster Recovery Tool' in the Windows Start Menu.

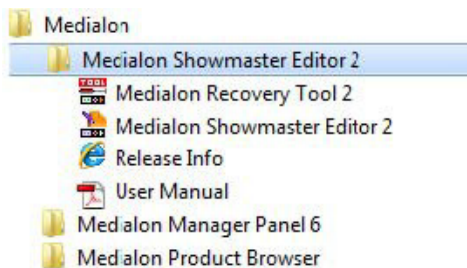

```

[msmrt] Medialon Showmaster Recovery Tools 2.1.0
[msmrt] Type 'help' for help.
[msmrt] Initializing...
[msmrt] Ready.
[msmrt] > mode tcp
[msmrt] Connection mode set to 'tcp'.
[msmrt] > scan
[msmrt] Scanning...
[msmrt] Found: Showmaster-ZI1747 '192.168.144.223' - Showmaster SI.
[msmrt] Found: Showmaster-B0386A '192.168.144.240' - Showmaster SI.
[msmrt] Found: Showmaster-91A118 '192.168.144.165' - Showmaster XS.
[msmrt] Found: Showmaster-B19696 '192.168.144.181' - Showmaster Pro.
[msmrt] Found: Showmaster-912760 '192.168.144.163' - Showmaster LE.
[msmrt] > connect Showmaster-ZI1747 medialon
[msmrt] Connecting Showmaster 'Showmaster-ZI1747'...
[msmrt] Showmaster 'Showmaster-ZI1747' connected.
[msmrt] >

```

The Medialon Showmaster Recovery Tool can only be used when Showmaster is started in Recovery Mode.

## Get Connected

Your computer can be connected to Showmaster using a serial (null modem) cable plugged into the Showmaster's Serial port 1. It is also possible to use a network connection to establish the communication.

### Serial Connection



1. If your computer uses COM port 4, type  
`mode serial 4`
2. Medialon Recovery Tool's response:  
`Connection mode set to 'serial'`
3. Type connect plus a space and the password (The default password is 'medialon')  
`connect medialon`
4. Medialon Recovery Tool's response:  
`Showmaster connected.`

### Network Connection

1. Type  
`mode tcp`
2. Medialon Recovery Tool's response:  
`Connection mode set to 'tcp'.`
3. Type  
`scan`

Showmaster Maintenance

4. Medialon Recovery Tool returns the list of Showmasters
5. Type connect plus the name of the Showmaster and the password (The default password is 'medialon')

```
connect Showmaster-ZT1747 medialon
```

6. Showmaster's response:

```
Showmaster Showmaster-ZY1747 connected.
```

## Console Commands

### Symbol Conventions

- [ ] means an optional parameter, for example, [value]
- < > means a required parameter, for example, mode serial <COM Port>
- | is the parameter's value separator, for example, <'on'|'off'>
- ' ' is the parameter's value, for example, 'on'
- " " indicates a comment
- [msmrt] > indicates commands you enter
- [msmrt] indicates Medialon Recovery Tool's response



The first letters of a command can be used instead of typing the full command if the 'shortcut' identifies a unique command.

### help or ?

Displays information about available commands.

### help

Displays help information about the given command.

### vers

Displays the current version of Medialon Showmaster Recovery Tools.

### cls

Clear the Recovery console window.

### exit

Quit the Recovery Tools application.

Showmaster Maintenance

### **mode <'tcp'|'serial' [portnumber]>**

Set the communication mode.

- *tcp*: use network communication
- *serial [portnumber]*: use a serial connection from COM [portnumber]

*Example:*

```
[msmrt] > mode serial 1
[msmrt] Connection mode set to 'serial'
```



Serial communication: connect a RS232 crossover (null-modem) cable between Showmaster's Serial Port 1 and your computer's COM [portnumber].

### **scan**

Scan for available Showmasters on the network.

*Example:*

```
[msmrt] > scan
[msmrt] Scanning...
[msmrt] Found: Showmaster-B03F1D '192.168.144.242' - Showmaster Pro
```

### **scan [delay]**

Scan for available Showmasters on the network with a delay expressed in milliseconds. Delay is the total time scanning should take place.

### **connect**

Open communication with the Showmaster connected to the COM port.

### **connect**

Opens a connection to Showmaster named on the network. The default password is '*medialon*'.

*Example:*

```
[msmrt] > connect Showmaster-B038AE medialon
[msmrt] Connecting Showmaster 'Showmaster-B038AE'...
[msmrt] Showmaster 'Showmaster-B038AE' connected
```



A scan command is needed before using the connect command if using the network to connect to the Showmaster.



Showmaster Maintenance

## disconnect

Closes the connection with Showmaster.

*Example:*

```
[msmrt] > disconnect
[msmrt] Disconnecting...
[msmrt] Disconnected
```

## reboot

Sends a reboot command to Showmaster.

## shutdown

Sends a shutdown command to Showmaster.

## get conf

Gets Showmaster's system configuration.

*Example:*

```
[msmrt] > get conf
[msmrt] Name: Showmaster-B038AE.
[msmrt] System Version: 1.0.0.
[msmrt] System Status: Recovery Mode.
[msmrt] IP Address: 192.168.144.80.
[msmrt] IP Mask: 255.255.255.0.
[msmrt] IP Gateway: 192.168.144.253.
[msmrt] Primary DNS: 192.168.144.107.
[msmrt] Secondary DNS: .
[msmrt] DHCP: Off.
[msmrt] MAC Address: XX.XX.XX.XX.XX.XX
[msmrt] Serial Number: 33070000
[msmrt] Log Status: On.
[msmrt] Log Buf Size: 1000.
[msmrt] Log SM Cue Trc: Off.
[msmrt] Log MxM Trc: Off.
[msmrt] Log MxM Cmd Trc: On.
[msmrt] Log RT Status: On.
[msmrt] Log RT Period: 600.
[msmrt] Log Hist Size: 7
```

## set conf

Set system configuration to have new parameters (examples below).

Before using this command, a *'getconf'* command is required.

 To apply all changes, use the 'commit' command.

### System Parameters

- name: Showmaster's user-defined Name

*Example:* set conf name smaster1

- address: Showmaster's IP address

*Example:* [msmrt] > set conf address 192.168.1.79

```
[msmrt] IP Address set to '192.168.1.79' (call 'commit' to apply)
```

- mask: subnet mask.

*Example:* set conf mask 255.255.255.0

- gateway: gateway address

*Example:* set conf gateway 192.168.1.254

- pridns: primary DNS address

*Example:* set conf pridns 192.168.1.1  
set conf pridns ns0.dnsserv.net

- secdns: secondary DNS address

*Example:* set conf secdns 192.168.1.2  
set conf secdns ns1.dnsserv.net

- dhcp: enable <'on'> or disable <'off'> automatic IP addressing of Showmaster

*Example:* set conf dhcp on

- log: enable <'on'> or disable <'off'> Showmaster log traces

*Example:* set conf log on

- logbufsize: defines the buffer size (expressed in messages) for Showmaster's log traces

*Example:* set conf logbufsize 10000

- logtracecues: enable <'on'> or disable <'off'> log traces of the cues executed in tasks

*Example:* set conf logtracecues on

- logmxmtrace: enable <'on'> or disable <'off'> log traces of MxMs

*Example:* set conf logmxmtrace off

- logmxmcmdtrace: enable <'on'> or disable <'off'> log traces of commands executed by the MxMs

*Example:* set conf logmxmcmdtrace off

 'logmxmtrace' must be set to 'on' before MxM commands can be traced.

## Showmaster Maintenance

- logrt: enable <'on'> or disable <'off'> log traces of Showmaster's run-time information like memory usage, handles, etc.

Example: `set conf logrt off`

- logrtperiod: defines the time period (expressed in milliseconds) between Showmaster's run-time log traces

Example: `set conf logrtperiod 3000`

- loghistsize: defines the size (expressed in days) of log trace history

Example: `[msmrt] > set conf loghistsize 10`  
`[msmrt] Log History Size set to '10' (call 'commit' to apply)`

### commit

This command is used to send the changes to Showmaster. You only need to send a single 'commit' after multiple 'set conf' operations.

Example:

```
[msmrt] > commit
[msmrt] Showmaster is being rebooted.
```

-  The Showmaster may disconnect or reboot after a 'commit' command.

### list

Lists components of the selected type.

Example:

```
[msmrt] > list prj
[msmrt] Prj - Default.swmProBckProj6
[msmrt] Prj - Default.swmProProj6
[msmrt] Prj - Default.swmVarStor6
```

### clear

Deletes the component of the selected type.

Example: `clear Cfg`

Component types:

- Prj: Project files.
- Cfg: Config files.
- Log: Log traces.
- Img: Bitmap files added in the project

Showmaster Maintenance

- ResImg: Resources Images built-in

### factory

Reset the firmware to factory default. See also [Showmaster Firmware](#). To confirm the operation, use the 'commit' command.

```
[msmrt] > factory
[msmrt] To confirm factory reset, type *commit*.
[msmrt] **If this operation is committed,**
[msmrt] **Showmaster will be reset to its default factory settings!**
[msmrt] **If you don't wish a factory reset, use 'cancel' to clear this command.**
```



This operation also deletes the current project loaded in Showmaster. Remember to save a copy of it.

## 3.2.3 Test Mode Commands

Test Mode allows the user to check Showmaster's resources.



### test <'on'|'off'>

Enters Test Mode <'on'>

Set Test Mode to Off to leave Test Mode.

Example:

```
[msmrt] > test on
[msmrt] Test set to On.
```



The front panel display indicates Test Mode status

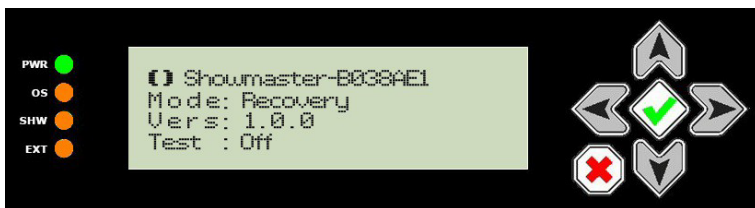

The following commands are only available when Medialon Showmaster is in Test Mode.



## Serial Resources

### open serial

Opens serial port.

Example:

```
[msmrt] > open serial 2  
[msmrt] Serial Port 2 is opened.
```

### close serial

Closes serial port.

Example:

```
[msmrt] > close serial 2  
[msmrt] Serial Port 2 is closed.
```



The front panel display indicates the status of the serial ports



### set serial <portnumber> "<baud> <databits> <parity> <stopbits>"

Sets up communication for serial port .

- *portnumber*: serial port number
- *baud*: baud rate
- *databits*: data bits (typically 8)
- *parity*: 'N' none, 'O' odd or 'E' even
- *stopbits*: stop bits (typically 1)

Example:

```
[msmrt] > set serial "2 19200 8 N 1"
```

### set rts <portnumber> <"on"|"off"|"hchk">

Sets RTS of serial port <portnumber>.

"hchk" turns on hardware handshaking for RTS/CTS

Example:

```
[msmrt] > set rts 3 hchk
```

Showmaster Maintenance

**set dtr** <portnumber> <"on"|"off"|"hchk">

Sets DTR of serial port.

"hchk" turns on hardware handshaking for DTR/DSR

*Example:*

```
[msmrt] > set dtr 3 hchk
```



'Events' report input activity in the Showmaster Recovery Tools console window.

**event serial** <portnumber> <"on"|"off">

Turns on or off event reporting for serial port <portnumber>.

*Example:*

```
[msmrt] > event serial 2 on  
[msmrt] Event Serial 2 set to On.
```

Example of event received:

```
[msmrt] Serial Evt - Port 2 Size 6, 'Hello!0D'.
```

**write serial** <portnumber> <data>

Sends out serial port.

- <data> is a test string using '!XX' notation for hexadecimal bytes

```
[msmrt] > write serial 2 Hello!0D
```



## Digital I/O Resource

### open digital

Opens the Digital I/O resource

*Example:*

```
[msmrt] > open digital  
[msmrt] Digital Resource is opened.
```

Showmaster Maintenance

### close digital

Closes the Digital I/O resource

Example:

```
[msmrt] > close digital  
[msmrt] Digital Resource is closed
```

### event digital <"on"|"off">

Turns on or off event reporting for digital inputs

Example: `event digital on`

### Write digital <outputnumber> <"on"|"off">

Sets relay output <outputnumber> to 'on' or 'off'.

Example: `write digital 3 on`

### get digital <outputnumber>

Reports the status of relay output <outputnumber>.

Example: `get digital 8`

```
- response: `xxx 8 on`
```



The 'get digital' command and 'Events' report digital input activity in the Showmaster Recovery Tools console window.



## DMX512 Resources

### open dmx <portnumber>

Opens DMX port <portnumber>

Example:

```
[msmrt] > open dmx 1  
[msmrt] DMX Port 1 is opened.
```

### close dmx <portnumber>

Close the DMX port.

Example:

```
[msmrt] > close dmx 1  
[msmrt] DMX Port 1 is closed.
```

**write dmx** <portnumber> <channelnumber> <level>

Set DMX channel to.

Example:

```
[msmrt] > write dmx 1 3 125
```



In Recovery Mode, all DMX resources are treated as outputs. It is not possible to read a DMX channel's level with the 'get' command or by using event reporting.



## MIDI Resources

**open midi**

Opens the MIDI ports.

Example:

```
[msmrt] > open midi  
[msmrt] MIDI Port is opened.
```

**close midi**

Closes the MIDI ports.

Example:

```
[msmrt] > close midi  
[msmrt] MIDI Port is closed.
```

**event midi** <"on" | "off">

Turns on or off event reporting for the MIDI In port.

Example:

```
[msmrt] > event midi on  
[msmrt] Event MIDI set to On.
```

Example of event received:



```
[msmrt] MIDI Evt - Size 3, '!90!01!7F'.
```



'Events' report MIDI input activity in the Showmaster Recovery Tools console window.

### **write midi** <data>

Send <data> from MIDI Out port.

- <data> is a test string using '!XX' notation for hexadecimal bytes

*Example:*

```
[msmrt] > write midi !90!01!7F
```



## **Timecode Resource**

### **open timecode**

Opens the Timecode Input resource.

*Example:*

```
[msmrt] > open timecode  
[msmrt] Timecode Port is opened.
```

### **close timecode**

Closes the Timecode Input resource.

*Example:*

```
[msmrt] > close timecode  
[msmrt] Timecode Port is closed.
```

### **event timecode** <"on"|"off">

Turns on or off event reporting for the Timecode Input.

*Example:*

```
[msmrt] > event timecode on  
[msmrt] Event Timecode set to On.
```

*Example of event received:*

```
[msmrt] Timecode Evt - Size 11, '00:01:43/14'.
```



Timecode 'Events' report changing timecode values once per second (so the Showmaster Recovery Tools console window does not scroll too quickly).

### 3.3 Showmaster Logs

Medialon Showmaster traces its main activity into logs. Showmaster Editor V2 provides a way for you to read these logs.

1. Connect Showmaster Editor to a Showmaster.

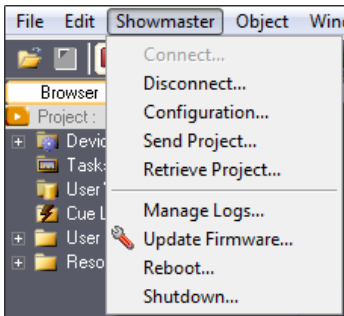

2. Select Manage Logs from the Showmaster menu.

3. The Manage Logs window opens.

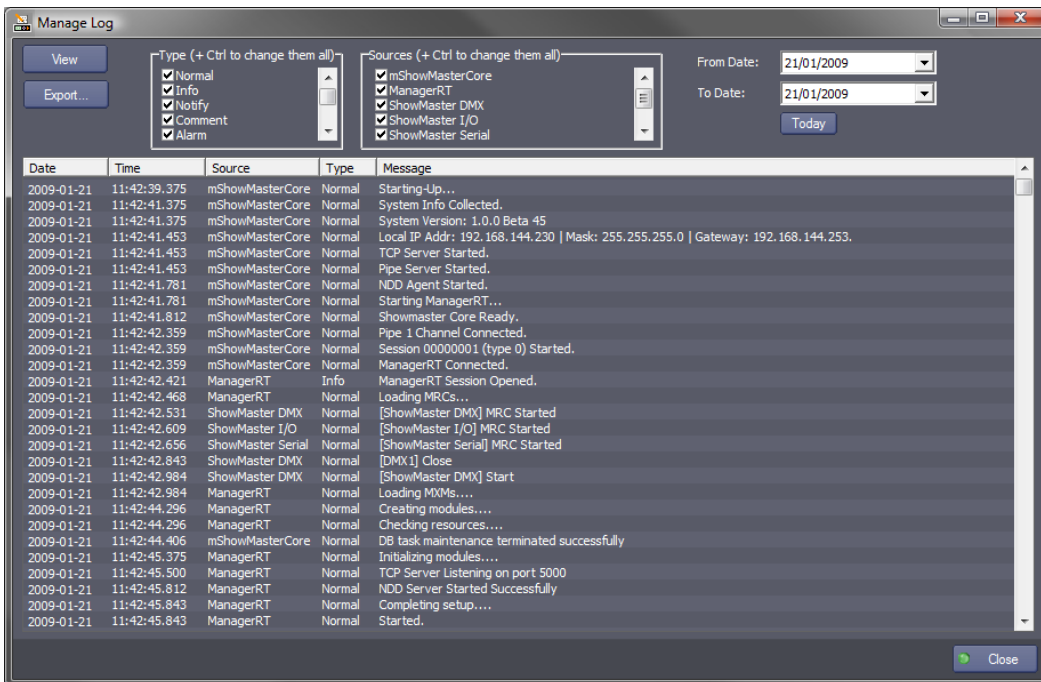

#### 3.3.1 Manage Logs Windows

With the Manage Logs window, you can View or Export all or part of Showmaster's logs.

Logs can be filtered by date.

## Showmaster Maintenance

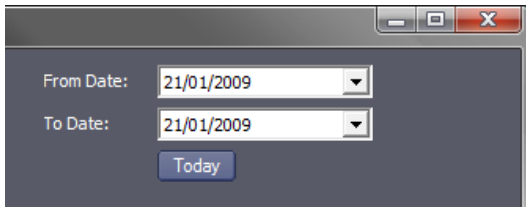
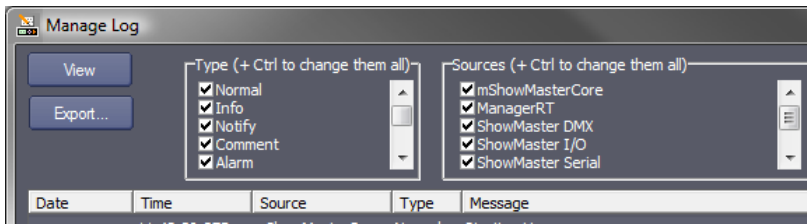

Select the type of messages you want to read:

- *Normal*: This type of message is for all events that executed normally in the running processes of Showmaster.
- *Info*: This type of message is a highlighted normal event.
- *Notify*: This type of message indicates an unusual event that occurred spontaneously, it has a little bit more importance than the Normal type.
- *Comment*: a comment.
- *Alarm*: Something which is not critical has occurred, but should not normally occur. It shouldn't have a big impact, but should be checked.
- *Error*: An error occurred which has significant impact. Something is no longer working.
- *Fatal*: The same as Error, but it makes the system stop working.
- *Debug*: Low Level traces, should be activated after a request by Medialon support.

Select the sources of messages:

- *mShowmasterCore*: Showmaster's main engine
- *ManagerRT*: the show control project engine
- *Showmaster DMX*: DMX resources
- *Showmaster I/O*: Relay and Digital Input resources
- *Showmaster MIDI*: MIDI resources
- *Showmaster Serial*: Serial resources
- etc.



This list depends on active Medialon MxMs inside the Medialon Showmaster.

The following lists of message descriptions is non-exhaustive.

## 3.3.2 Notify Messages

### mShowmasterCore Messages

- *< Session ID xxx asked to reboot Showmaster >*  
The session xxx (connection from Showmaster Editor V2 or Medialon Recovery Tools) has asked to reboot Showmaster.
- *< Session ID xxx asked to shutdown Showmaster >*  
The session xxx (connection from Showmaster Editor V2 or Medialon Recovery Tools) has asked to shutdown Showmaster.
- *< Session ID xxx asked to reset Showmaster to factory >*  
The session xxx (connection from Showmaster Editor V2 or Medialon Recovery Tools) has asked to reset Showmaster to its factory state.

## 3.3.3 Alarm Messages

### mShowmasterCore Messages

- *< ManagerRT doesn't answer, process killed... >*  
ManagerRT has been killed by mShowmasterCore because it stopped responding.
- *< Client connection(s) have been forced closed >*  
The client connections (Showmaster Editor V2, Medialon Manager) have been forced closed by holding the down arrow on the front panel.
- *< ManagerRT not responding (PID: xxx) >*  
ManagerRT is no longer responding to the watch process.

## 3.3.4 Error Messages

### mShowmasterCore Messages

- *< Session Start Error: Too many sessions opened >*  
Showmaster is already connected to another Showmaster Editor V2.
- *< Unable to initialize Front Panel >*  
The communication/initialization with the Front panel failed.
- *< Unable to collect system info >*  
System information cannot be collected.
- *< Unable to start TCP Server >*  
The TCP server for Showmaster Editor V2 and Medialon Manager connections cannot be started.
- *< Unable to start Pipe Server >*  
The server that manages the dialog with ManagerRT cannot be started.

- *< Unable to start Serial Server >*  
The server that manages the Recovery Tool serial connection cannot be started (Recovery Mode only).
- *< Unable to start NDD Agent: xxx >*  
The agent that manages network detection connection cannot be started, xxx gives a description of the error.
- *< Unable to restart NDD >*  
The agent that manages network detection connection cannot be restarted.
- *< ManagerRT shutdown failed: xxx >*  
ManagerRT cannot be stopped due to xxx error.
- *< ManagerRT shutdown failed: xxx >*  
ManagerRT cannot be shut down due to xxx error.
- *< Session Start Error: xxx >*  
A session cannot be started due to xxx error.
- *< Session xxx Stop Error: xxx. >*  
The session xxx is stopped with xxx error.
- *< Switch mode failed: xxx >*  
Showmaster mode switching failed with error xxx.

## ManagerRT Messages

- *< Project File Load Error: Warning during loading of file >*  
The current project is not running normally; check it with Showmaster Editor V2.
- *< Failed to load the device 'Device\_Name' supported by the MxM 'MxM\_Name'. All references to this device will be lost >*  
The current project may have been edited with a different firmware than the one currently installed on the Showmaster. Check the firmware version and current project with Showmaster Editor V2.

## 3.3.5 Fatal Messages

### mShowmasterCore Messages

- *< LICENSE MISSING: Waiting for license... >*  
Showmaster is not licensed, a license file must be provided; contact your dealer.
- *< Failed to start ManagerRT: xxx >*  
ManagerRT cannot be started due to xxx error.
- *< ManagerRT Stopped due to zero division error >*  
A zero division error occurred in the project; runtime has stopped.

## ManagerRT Messages

- ManagerRT Task Kernels Timed Out.
- ManagerRT Task Condition Kernel Timed Out.

## 3.4 Showmaster Troubleshooting

This section helps resolve problems you may encounter while using Medialon Showmaster V2.

### 3.4.1 Showmaster

Common Problems and Solutions:

Problem	Check These Items
Does not turn on	Check that the power cable is plugged in. Check that the rear power switch is On.
Showmaster V2 Status indicator (LED OS) does not turn on	Reboot the Showmaster in Recovery Mode. Contact your dealer; this Showmaster may need to return to the factory.
Showmaster V2 Status indicator (LED OS) lights red	Contact your dealer; this Showmaster may need to return to the factory.
Project Status indicator (LED SHW) does not turn on	Check project presence with Showmaster Editor V2. Check project presence with Recovery Tools.
Project Status indicator (LED SHW) lights red	Check the project with Showmaster Editor V2. Delete the current project with Recovery Tools.
No DMX signal	Check that the DMX cable is plugged in. Check DMX sending with Showmaster Editor V2. Check DMX sending with Recovery Tools.
No MIDI signal	Check that the MIDI cable is plugged in (for Showmaster V2 ST) Check MIDI sending/receiving with Showmaster Editor V2. Check MIDI sending/receiving with Recovery Tools.
No Serial communication	Check that the Serial cable is plugged in. Check the Serial pinout of the connected device. Check Serial sending/receiving with Showmaster Editor V2. Check Serial sending/receiving with Recovery Tools.
Digital Relay Output not switching	Check that the Relay cable is plugged in. Check Relay commands with Showmaster Editor V2. Check Relay commands with Recovery Tools.
No Digital Input contact detected	Check that the Input cable is plugged in. Check Input receiving with Showmaster Editor V2. Check Input receiving with Recovery Tools.
No Network connection	Check that the network cable is plugged in. Check the activity LED on network socket. Check the Showmaster's IP configuration.
Front panel displays 'License...'	Contact your dealer; this Showmaster may need to return to the factory.

Problem	Check These Items
Front panel displays 'Run Fault'	The project has caused a runtime error. Check the project with Showmaster Editor V2. Delete the current project with Recovery Tools.
Showmaster is not responding after a firmware update	Manually reboot the Showmaster. Try a new firmware update from Showmaster.
Editor V2	Reset firmware to Factory Default.
No text on front panel display	Contact your dealer, this Showmaster may need to return to the factory.
Not responding to Front panel keypad	Contact your dealer, this Showmaster may need to return to the factory.

### 3.4.2 Showmaster Editor V2

Common Problems and Solutions:

Problem	Check These Items
Showmaster is not scanned	Check network connection and configuration. Check recovery mode.
Cannot upload project	Check project presence with Recovery Tools
Cannot download project	Check network connection and configuration. Check recovery mode.
Forget Connection Password	Contact Medialon Support.
Firmware upgrader generation failed	Check USB stick Disk full or locked.

For further information, contact your Medialon dealer.

# Contact Us

---

Find more on our website <https://7thSense.one> and on social media. For documentation, visit <https://portal.7thSense.one>



or contact our support team at [support@7thSense.one](mailto:support@7thSense.one)







E: [info@7thsense.one](mailto:info@7thsense.one)

W: [7thsense.one](http://7thsense.one)

**7thSense Design Ltd**

2 The Courtyard Shoreham Road  
Upper Beeding  
Steyning  
West Sussex  
BN44 3TN  
UK

T: +44 (0) 1903 812299

**7thSense LLC, Michigan**

332 E Lincoln Ave  
Suite 100  
Royal Oak, MI 48067  
USA

T: +1 248 599 2717

**7thSense LLC, Orlando**

4207 Vineland Rd  
Suite M1  
Orlando, FL 32811  
USA

T: +1 407 505 5200

---